

Catalogue



German Engineered.
Global Presence. Top Safety.

- Since 1986

Deployed all over Europe

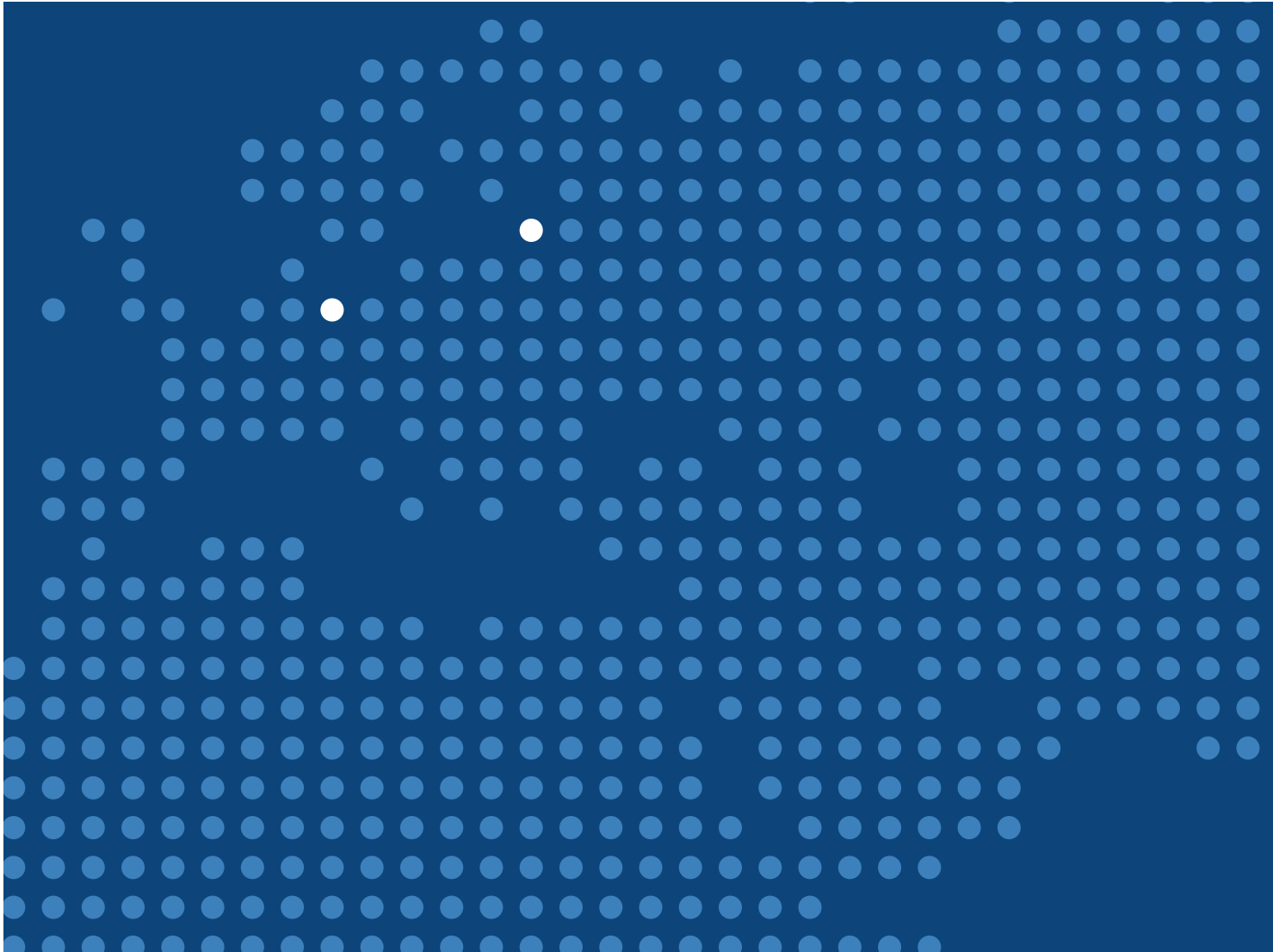

Version June 2023

Subject to technical changes and copyright. Deliveries are exclusively subject to our conditions of sale and delivery. This catalogue is our intellectual property! Re-printing and reproduction – including excerpts – as well as the use of our images, is only permitted with our prior written permission. We assume no warranty for the data, descriptions, representations, notes and recommendations for use of the products available from our company and detailed in this catalogue. In principle, legal claims cannot be made based on this because deployment and use are generally beyond our control. Moreover, users are obliged to check and decide for themselves whether the items offered by our company can be used in individual cases.

Table of Contents

General	4
Cargo securing for tarpaulin and platform vehicles	12
Lashing straps	13
Edge protection and non-slip mats	20
Longitudinal bars	22
Parting wall locks	23
Double-deck system for curtainsiders	24
FIX products	27
Daken products	32
Cargo securing for box trucks	36
Lashing tracks	37
Lashing straps	44
Shoring beams	46
Cargo bars	54
Decking beams	55
Garment rails	58
Door gears	59
Cargo securing for transporters and trailers	60
Airline lashing rails	61
Lashing points	78
Fittings / end fittings and accessories	80
AirlineStop	85
Lashing straps	86
Cargo securing nets	93
Shoring beams	107
Parting wall locks	116
Garment rails	116
Cargo securing wall for transporters	117
Cargo securing for car transporters and trailers	118
Car transport lashings straps	119
Other	122
Lifting technology	123
Security seals and anti-theft devices	127
Ratchets	128
One-way lashing	134
Edge protection	144
Interesting facts	148

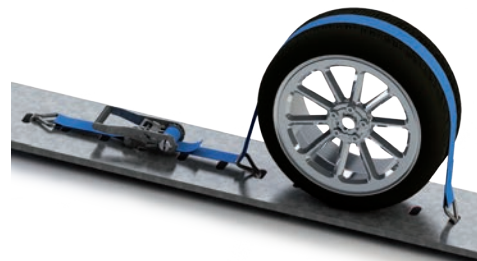

Our experience guarantees your safety!

Dear customer,

We are pleased to welcome you with our current catalogue.

On the following pages you will be able to acquaint yourself with WISTRA GmbH.

The individual categories will provide you with an overall impression of the capability of our modern company and of our products and services.

Besides our well-known products, we present the latest product developments and accessories of our product range.

We look forward to working with you and wish you pleasant browsing in our catalogue.

Yours



Mark Zubel



The company

WISTRA offers a wide product range of textile and mechanical aids for cargo securing.

Our market position is based on competent staff who fulfil your needs with expertise and experience as well as application-oriented and high-quality products at market-related prices.

WISTRA – your first contact for innovative cargo securing systems in Europe

In addition, we are a member of the Heico Group with American market leaders in the field of cargo securing in development and production.

More than 30 years of quality, continuous further development and technical modernisation

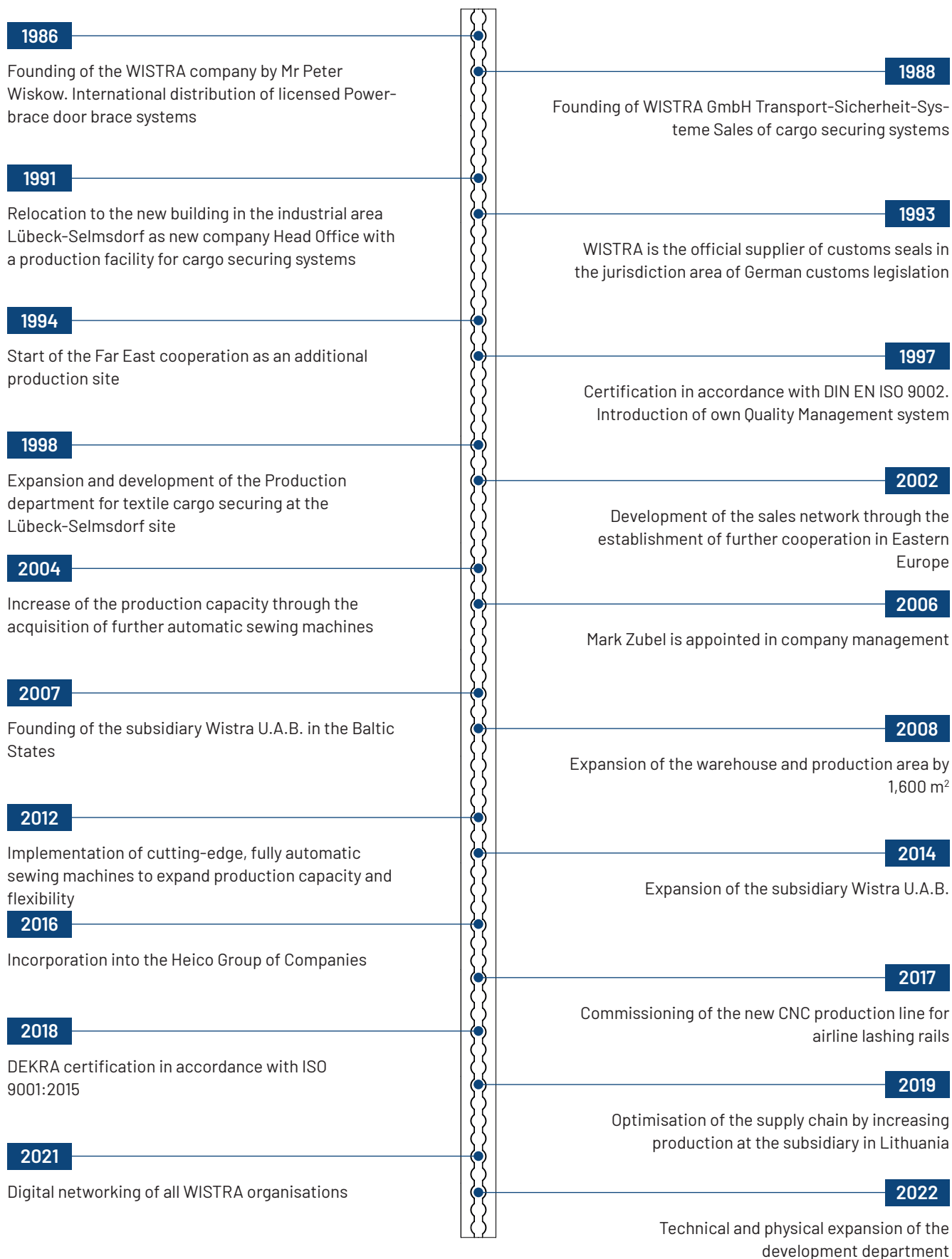



6



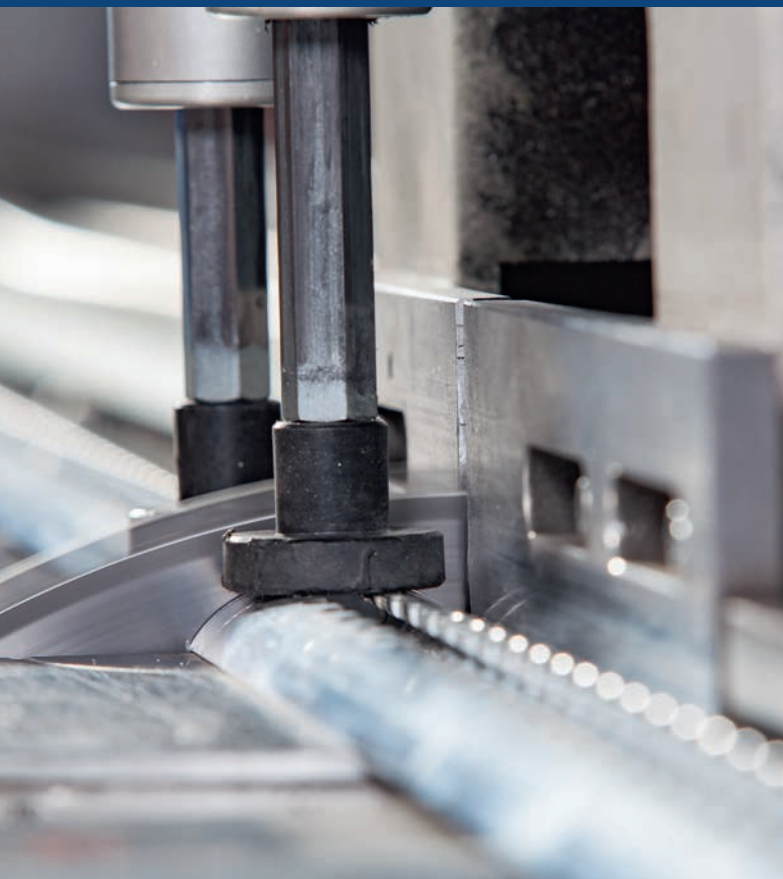

Certified safety in development and production

Quality

All products of the WISTRA product range are subjected to stringent safety tests.

Our Quality Management forms the basis for guaranteeing our consistently high quality.

Most of the products in our range are subjected to extraordinary continuous loading. Therefore, the materials processed by us always undergo extensive test series.

This means optimum safety levels for our customers.

Production

Almost all products for textile and mechanical load securing are developed and designed by us.

Competent specialists ensure the installation and production of all our products in compliance with quality requirements with our modern machinery.

Years of cooperation with supplier partners worldwide make it possible for us to offer you an excellent price-performance ratio.

As a result of this cooperation, we can offer you a broad spectrum of special solutions, including the products of the "Fix Products" series, which we manufacture as the exclusive partner for Central Europe. Thanks to our own production line in Europe, we have created the necessary conditions in the sector of airline lashing rails to produce completely individual and tailor-made configurations for you - no matter how many hole pitches and radii.

You are certain to find the right solution for your individual requirements at WISTRA!

Overview of our securing equipment

Textile load securing

Our decades of experience and the continuous further development and supplementation of our product range enable us to offer you exceptionally designed solutions for textile load securing.

Be it air, water, rail or road – we have solutions for the individual requirements of your company regarding cargo securing.

Daily deployment under the most varied conditions proves the high degree of reliability of our products and affirms our use of the latest thermal processes.

WISTRA lashing straps are tested and manufactured to the highest standards in accordance with DIN EN 12195-2.

Our SAFEGUARD cargo securing nets are developed specifically for transport goods, adapted and made up individually. Manufacturing, marking and testing is performed in accordance with the VDI Guideline 2700 Part 3.3.

Many well-known logistics companies and global players use our SAFEGUARD cargo securing nets successfully in the areas of rail, postal, parcel service and general cargo.



example: cargo nets to hold down cargo



example: lashing strap with quick-view label

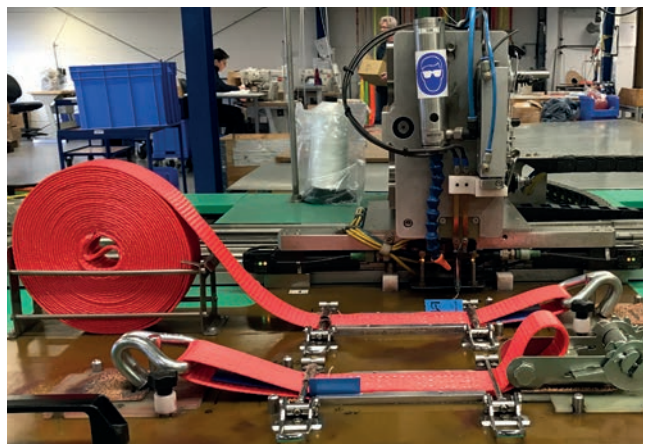

example: production of lashing straps

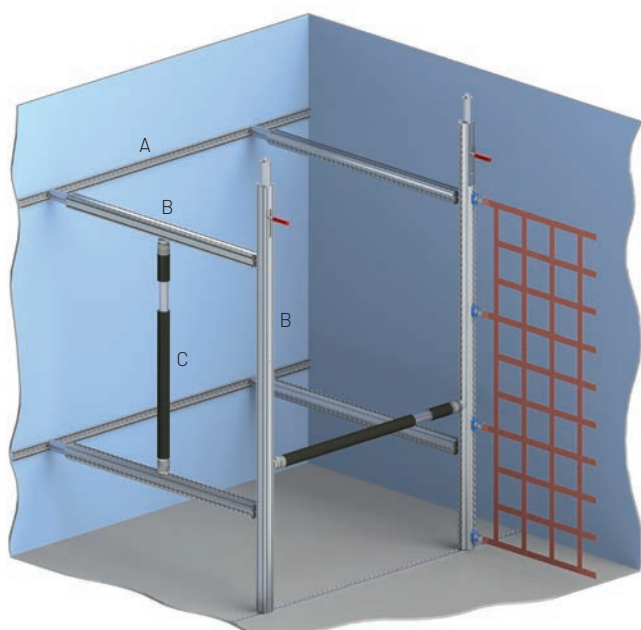

A = Airline Rails
B = Shoring Beam
C = Airline Beam

Mechanical cargo securing

We have developed customs-proven load securing devices of the highest level in cooperation with the Customs Crime Institute.

The patented WISTRA shoring beam POWERSTOP resulted from this, which is used to seal cavities in vehicles and can withstand loads of up to 2.5 t.

POWERSTOP is a real Hercules among cargo securing systems and is mainly used in the combined cargo traffic on road and rail.

The rigid cargo securing devices are generally summarised in the mechanical cargo securing product group. We protect the cargo in all vehicles safely and in form-fit shape.

WISTRA has designed many of these products as unit construction systems. This enables the use of various cargo securing devices for the rails and wall panels currently installed in vehicles.



example: airline beam and shoring beam in use

For vans and trailers

Textile load securing systems, such as lashing straps and particularly cargo nets from the SAFEGUARD series, form part of the supply range for vans and trailers. These nets are available in many standard versions proven during practical experience as well as individual solutions according to customer requirements.

WISTRA cargo nets can be used to partition cargo space, for rear cargo securing and tying down cargo. They can be fixed to the standard lashing points mounted by the vehicle manufacturer. Matching end fittings can be found in this catalogue.

All other load securing systems, such as shoring beams and lashing straps, can, of course, be adapted to vans and trailers.

WISTRA thereby offers a complete and individual solution for cargo securing in vans and trailers.

Feel free to request a solution proposal for your special transport securing system. Our qualified employees will be happy to offer advice and to prepare a corresponding offer for you.

Security seals/theft protection

Owing to the opening of many borders for national and international trade, requirements for the safe transport of goods are increasing.

WISTRA has long been prepared for this situation and offers a broad range of security seals for your requirements regarding cargo securing.

WISTRA has assembled an extensive range of theft prevention systems in order to curb theft and manipulation. They are conceptualised in such a way that the entire means of transport is protected, at the same time preventing unauthorised access to the cargo.



container seal and anti-theft device

Lifting technology

The lifting technology range of WISTRA comprises round slings and lifting slings with reinforced end slings. They are only manufactured from tested material in order to meet the highest demands. Our round slings and lifting straps cover a cargo capacity of up to 10,000 kg and are manufactured according to current standards and are available in various lengths.



lifting strap and round sling

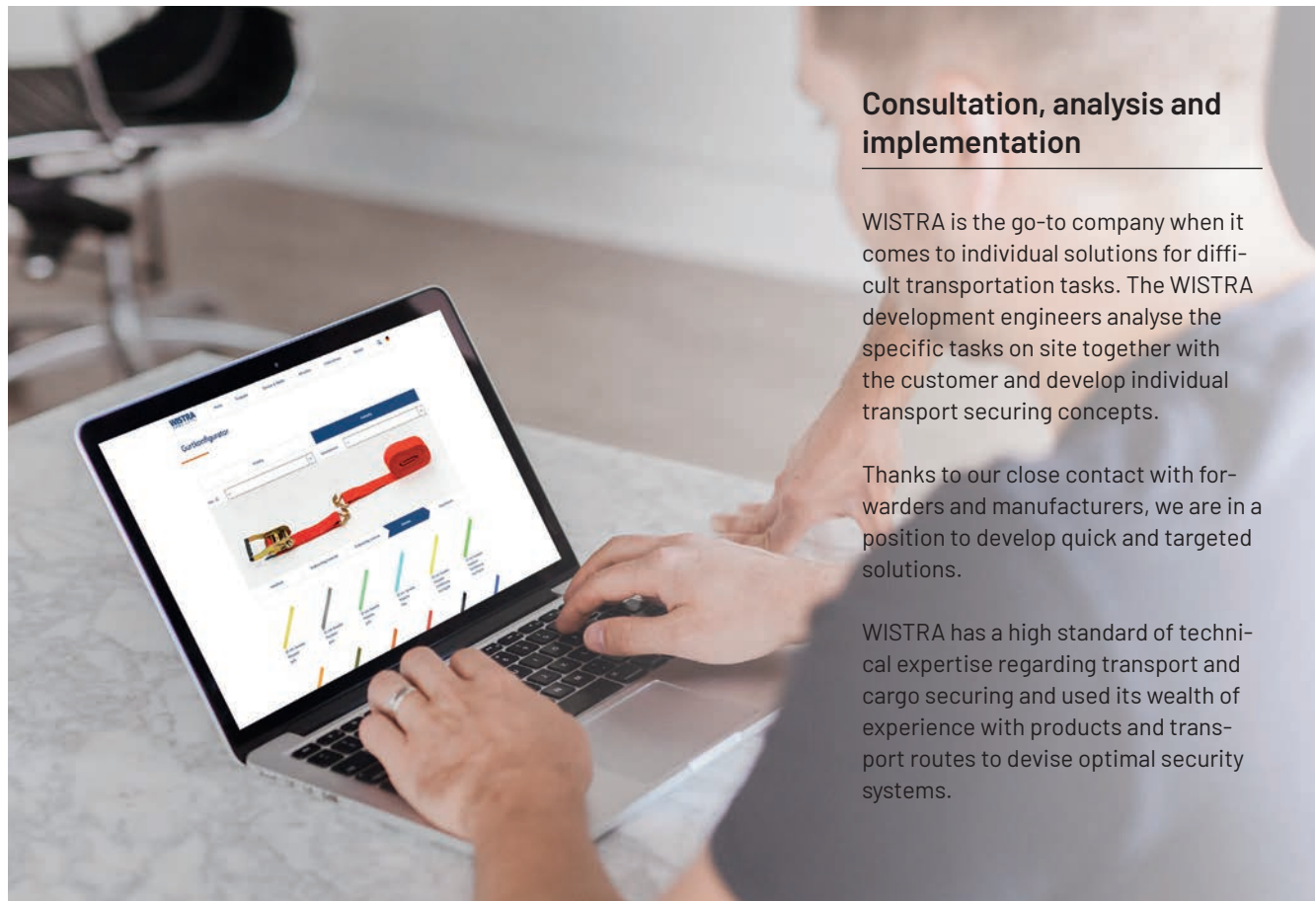

Consultation, analysis and implementation

WISTRA is the go-to company when it comes to individual solutions for difficult transportation tasks. The WISTRA development engineers analyse the specific tasks on site together with the customer and develop individual transport securing concepts.

Thanks to our close contact with forwarders and manufacturers, we are in a position to develop quick and targeted solutions.

WISTRA has a high standard of technical expertise regarding transport and cargo securing and used its wealth of experience with products and transport routes to devise optimal security systems.



Special requests

Various custom productions represent a special advantage for our customers.

WISTRA can supply lashing strap material in all colours and lengths, even if they do not appear in this catalogue.

Upon request, we can supply many items with your company logo and/or company name. Even customer-specific designs represent solvable challenges to us.

If you are unable to find an item in this catalogue, please contact us. Together, we are certain to find the right solution for you.

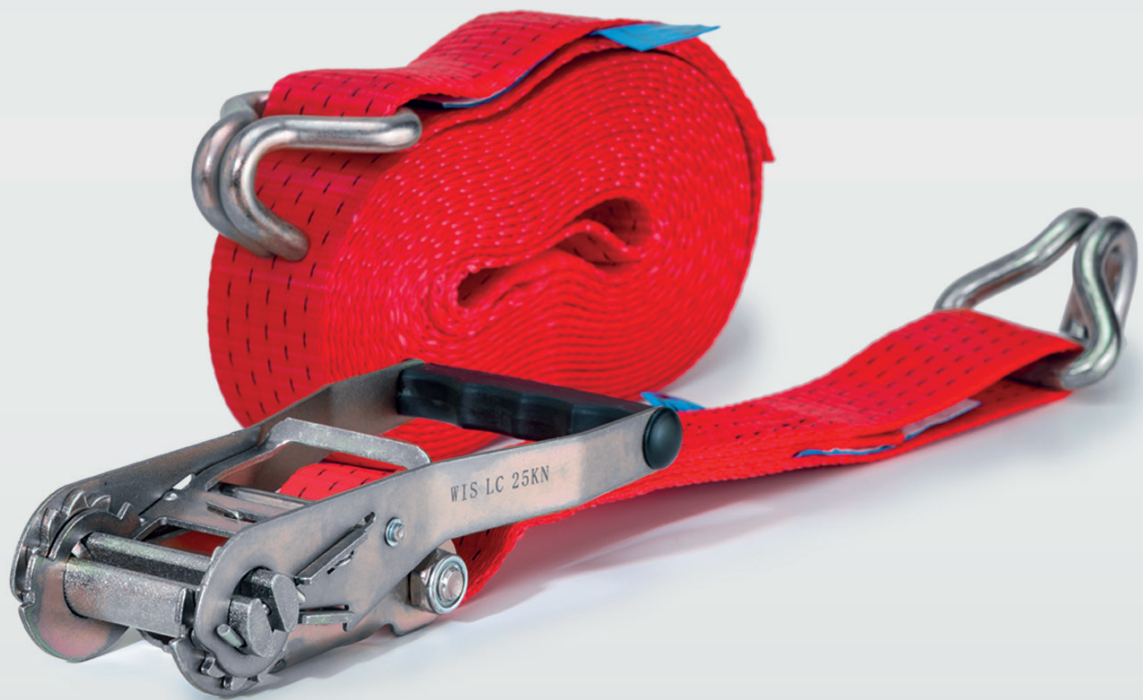

Top seller

WTR 5000-006 0.4 + 7.6 m red

More on page 13



Cargo securing for tarpaulin and platform vehicles

WTR 10000-067 Ratchet lashing strap



Technical data

- > two-part – SE 0.5 m + LE 3.5 m
- two-part – SE 0.5 m + LE 7.5 m
- two-part – SE 0.5 m + LE 11.5 m
- > according to EN 12195-2
- > LC 5,000 daN with straight tension
- > with end fitting **067** (claw hook)
- > strap: min. 100 mm, yellow
- > pressure ratchet

Designation	Item number
Ratchet lashing strap WTR 10000 claw hook 067 SE 0.5 + LE 3.5 yellow	1750535
Ratchet lashing strap WTR 10000 claw hook 067 SE 0.5 + LE 7.5 yellow	1750575

WTR 5000-006 Ratchet lashing strap



without imprint



with individual imprint in black as text or logo



many of the lashing straps are available with Quick View label

Technical data

- > two-part – SE 0.4 m + LE 7.6 m
- two-part – SE 0.4 m + LE 9.6 m
- > according to EN 12195-2 with Quick-View-Label
- > LC 2,500 daN with straight tension
- > STF 300 daN
- > with end fitting **006** (claw hook)
- > strap: 50 mm, red
- > pressure ratchet

Designation	Item number
Ratchet lashing strap WTR 5000 claw hook 006 SE 0.4 + LE 7.6 red quickview label	11811090060476L
Ratchet lashing strap WTR 5000 claw hook 006 SE 0.4 + LE 7.6 red quickview label with imprint	1507070
Ratchet lashing strap WTR 5000 claw hook 006 SE 0.4 + LE 9.6 red quickview label	11811090060496L
Ratchet lashing strap WTR 5000 claw hook 006 SE 0.4 + LE 9.6 red quickview label with imprint	1507072



Scan QR code and
watch video

[You can find the
video here](#)

WTE 5500-006 Ratchet lashing strap



without imprint



with individual imprint in black as text or logo

Technical data

- > two-part - SE 0.4 m + LE 7.6 m
- two-part - SE 0.4 m + LE 9.6 m
- > according to EN 12195-2
- > with Quick-View-Label
- > LC 2,500 daN with straight tension
- > STF 500 daN with ratchet 822
- > with end fitting **006** (claw hook)
- > strap: 50 mm, red
- > long-lever pull ratchet

Designation	Item number
Ratchet lashing strap WTE 5500 claw hook 006 SE 0.4 + LE 7.6 red quickview label	1500317L
Ratchet lashing strap WTE 5500 claw hook 006 SE 0.4 + LE 7.6 red quickview label with imprint	1500490
Ratchet lashing strap WTE 5500 claw hook 006 SE 0.4 + LE 9.6 red quickview label	1500323L
Ratchet lashing strap WTE 5500 claw hook 006 SE 0.4 + LE 9.6 red quickview label with imprint	1500324

WTL 5550-006 Ratchet lashing strap



without imprint



with individual imprint in black as text or logo

Technical data

- > two-part - SE 0.5 m + LE 7.5 m
- two-part - SE 0.5 m + LE 9.5 m
- > according to EN 12195-2
- > with Quick-View-Label
- > LC 2,500 daN with straight tension
- > STF 550 daN with ratchet 818
- > with end fitting **006** (claw hook)
- > strap: 50 mm, red
- > long-lever pull ratchet

Designation	Item number
Ratchet lashing strap WTL 5550 claw hook 006 SE 0.5 + LE 7.5 red quickview label	1502589LQV
Ratchet lashing strap WTL 5550 claw hook 006 SE 0.5 + LE 7.5 red quickview label with imprint	1506995QV
Ratchet lashing strap WTL 5550 claw hook 006 SE 0.5 + LE 9.5 red quickview label	1502591LQV
Ratchet lashing strap WTL 5550 claw hook 006 SE 0.5 + LE 9.5 red quickview label with imprint	1506997QV

WTR 5000-006 Ratchet lashing strap



Technical data

- > short end 0.4 m
- > according to EN 12195-2
- > with Quick-View-Label
- > LC 2,500 daN with straight tension
- > STF 300 daN with ratchet 811
- > with end fitting **006** (claw hook)
- > strap: 50 mm, red
- > pressure ratchet

Designation	Item number
Ratchet lashing strap WTR 5000 claw hook 006 SE 0.4 red quickview label	11811090060400L

WTE 5500-006 Ratchet lashing strap



Technical data

- > short end 0.4 m
- > according to EN 12195-2
- > with Quick-View-Label
- > LC 2,500 daN with straight tension
- > STF 500 daN with ratchet 822
- > with end fitting **006** (claw hook)
- > strap: 50 mm, red
- > long-lever pull ratchet

Designation	Item number
Ratchet lashing strap WTE 5500 claw hook 006 SE 0.4 red quickview label	1500310L

WTL 5550-006 Ratchet lashing strap



Technical data

- > short end 0.5 m
- > according to EN 12195-2
- > with Quick-View-Label
- > LC 2,500 daN with straight tension
- > STF 550 daN with ratchet 818
- > with end fitting **006** (claw hook)
- > strap: 50 mm, red
- > long-lever pull ratchet

Designation	item number
Ratchet lashing strap WTL 5550 claw hook 006 SE 0.5 red quickview label	1500714LQV

WTR 5000-006 Ratchet lashing strap



Technical data

- > long end – 7.6 m
long end – 9.6 m
- > according to EN 12195-2
- > with Quick-View-Label
- > LC 2,500 daN with straight tension
- > with end fitting **006** (claw hook)
- > strap: 50 mm, red

Designation	Item number
Ratchet lashing strap WTR 5000 claw hook 006 LE 7.6 red quickview label	1500947LQV
Ratchet lashing strap WTR 5000 claw hook 006 LE 9.6 red quickview label	1500434LQV

WTR 5000-206 Ratchet lashing strap



Technical data

- > two-part – SE 0.4 m + LE 7.6 m
- > according to EN 12195-2
- > with Quick-View-Label
- > LC 2,500 daN with straight tension
- > STF 300 daN
- > with end fitting **206** (claw hook with safety device)
- > strap: 50 mm, red
- > pressure ratchet

Designation	item number
Ratchet lashing strap WTR 5000 claw hook with retention 206 SE 0.4 + LE 7.6 red quickview label	11811092060476

WTR 5000-065 Ratchet lashing strap



Technical data

- > two-part – SE 0.4 m + LE 7.6 m
- > according to EN 12195-2
- > with Quick-View-Label
- > LC 2,500 daN with straight tension
- > STF 300 daN
- > with end fitting **065** (claw hook)
- > strap: 50 mm, red
- > pressure ratchet

Designation	Item number
Ratchet lashing strap WTR 5000 claw hook 065 SE 0.4 + LE 7.6 red quickview label	11811090650476

WTR 5000-075 Ratchet lashing strap



Technical data

- > two-part – SE 0.4 m + LE 7.6 m
- > according to EN 12195-2
- > with Quick-View-Label
- > LC 2,500 daN with straight tension
- > STF 300 daN
- > with end fitting **075** (triangle snap hook)
- > strap: 50 mm, red
- > pressure ratchet

Designation	Item number
Ratchet lashing strap WTR 5000 triangle snap hook 075 SE 0.4 + LE 7.6 red quickview label	11811090750476

WTR 5000-046 Ratchet lashing strap



Technical data

- > two-part – SE 0.4 m + LE 7.6 m
- > according to EN 12195-2
- > with Quick-View-Label
- > LC 2,500 daN with straight tension
- > STF 300 daN
- > with end fitting **046** (cropped claw hook for crown outer frame)
- > strap: 50 mm, red
- > pressure ratchet

Designation	Item number
Ratchet lashing strap WTR 5000 claw hook 046 SE 0.4 + LE 7.6 red 5%	1504441L

WTE 5500-206 Ratchet lashing strap



Technical data

- > two-part – SE 0.4 m + LE 7.6 m
- > two-part – SE 0.4 m + LE 9.6 m
- > according to EN 12195-2
- > with Quick-View-Label
- > LC 2,500 daN with straight tension
- > STF 500 daN with ratchet 822
- > with end fitting **206** (claw hook with safety device)
- > strap: 50 mm, red
- > long-lever pull ratchet

Designation	Item number
Ratchet lashing strap WTE 5500 claw hook with retention 206 SE 0.4 + LE 7.6 red quickview label	1500524
Ratchet lashing strap WTE 5500 claw hook with retention 206 SE 0.4 + LE 9.6 red quickview label	1500553

WTL 5550-206 Ratchet lashing strap



Technical data

- > two-part – SE 0.5 m + LE 7.5 m / two-part – SE 0.5 m + LE 9.5 m
- > according to EN 12195-2
- > with Quick-View-Label
- > LC 2,500 daN with straight tension, STF 550 daN ratchet 818
- > with end fitting **206** (claw hook with safety device)
- > strap: 50 mm, red
- > with imprint long end
- > long-lever pull ratchet

Designation	Item number
Ratchet lashing strap WTL 5550 claw hook with retention 206 SE 0.5 + LE 7.5 red quickview label	1258548
Ratchet lashing strap WTL 5550 claw hook with retention 206 SE 0.5 + LE 9.5 red quickview label	1502623

WTR 4000-006 Ratchet lashing strap



Technical data

- > two-part – SE 0.4 m + LE 7.6 m / two-part – SE 0.4 m + LE 9.6 m
- > according to EN 12195-2
- > with Quick-View-Label
- > LC 2,000 daN with straight tension, STF 300 daN
- > with end fitting **006** (claw hook)
- > strap: 50 mm, yellow
- > pressure ratchet

Designation	Item number
Ratchet lashing strap WTR 4000 claw hook 006 SE 0.4 + LE 7.6 yellow quickview label	11811060060476L
Ratchet lashing strap WTR 4000 claw hook 006 SE 0.4 + LE 9.6 yellow quickview label	11811060060496L

WTR 2000-520 Ratchet lashing strap



Technical data

- > two-part – SE 0.5 m + LE 3.5 m / two-part – SE 0.5 m + LE 5.5 m / two-part – SE 0.5 m + LE 7.5 m
- > according to EN 12195-2
- > LC 1,000 daN with straight tension, STF 240 daN
- > with end fitting **520** (claw hook)
- > strap: 35 mm, orange
- > pressure ratchet

Designation	item number
Ratchet lashing strap WTR 2000 claw hook 520 SE 0.5 + LE 3.5 orange	1350605
Ratchet lashing strap WTR 2000 claw hook 520 SE 0.5 + LE 5.5 orange	1350607
Ratchet lashing strap WTR 2000 claw hook 520 SE 0.5 + LE 7.5 orange	1350609

WTR 2000 Ratchet lashing strap

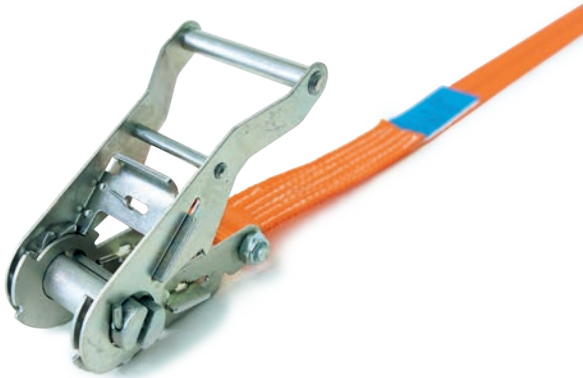

Technical data

- > single-part – 3.0 m / 5.0 m / 8.0 m
- > according to EN 12195-2
- > lashing capacity LC 2000 daN in strapping
- > STF 480 daN
- > strap: 35 mm, orange
- > pressure ratchet

Designation	Item number
Ratchet lashing strap WTR 2000 single-part 3.0 orange	1350995
Ratchet lashing strap WTR 2000 single-part 5.0 orange	1350997
Ratchet lashing strap WTR 2000 single-part 8.0 orange	1351000

WTR 2200-520 Ratchet lashing strap



Technical data

- > two-part – SE 0.5 m + LE 5.5 m
- > two-part – SE 0.5 m + LE 7.5 m
- > according to EN 12195-2
- > LC 1,000 daN with straight tension
- > STF 200 daN
- > with end fitting **520** (claw hook)
- > strap: 35 mm, orange
- > pressure ratchet

Designation	Item number
Ratchet lashing strap WTR 2200 claw hook 520 SE 0.5 + LE 5.5 orange	1353004
Ratchet lashing strap WTR 2200 claw hook 520 SE 0.5 + LE 7.5 orange	1353005L

Wheel chock

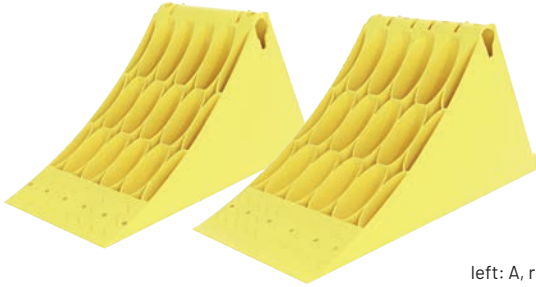

left: A, right: B

Technical data

- > suitable for tractor units, semi-trailers, trucks and trailers
- > material: plastic PP (recyclable)
- > colour: yellow
- > UV- and weather-resistant between -30°C and +50°C
- > central handle for easy handling
- > maximum tyre radius A: 460 mm
- > maximum tyre radius B: 555 mm
- > weight A: 0.75 kg
- > weight B: 1.19 kg

Designation	Item number
Wheel chock size 53	393001
Wheel chock size 46	393002

Wheel chock holder, round, galvanized with screw



Technical data

- > length: 250 mm
- > diameter: 21 mm
- > weight: 0.52 kg

Designation	Item number
Chock holder galvanized with screw	393006

Hot galvanized chock holder

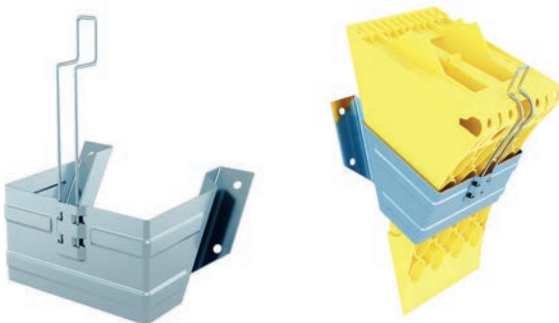

Technical data

- > bracket with retaining spring for wheel chock #393001, #393002
- > material: Sheet steel, hot-dip galvanized
- > L x W x H small: 166 x 120 x 174 mm
- > L x W x H big: 207 x 162 x 231 mm

Designation	Item number
Chock holder hot-dip galvanised for size 53	393008
Chock holder hot-dip galvanised for size 46	393007

Anti-slip mat



Technical data

- > material: PU bound rubber granulate
- > material thickness: 8 mm
- > coefficient of sliding friction $\mu = 0.6$
- > colour: black
- > weight: approx. 7.2 kg / m²

Anti-slip mat as pad:

- > size: 130 mm x 110 mm
- size: 300 mm x 200 mm

Designation	Item number
Anti-slip mat 130 x 110 x 8 mm	161108013081
Anti-slip mat 300 x 200 x 8 mm	162008030081

Anti-slip mat on a roll:

- > size: 5,000 mm x 250 mm
- > size: 5,000 mm x 500 mm
- > size: 10,000 mm x 1,250 mm

Designation	Item number
Anti-slip mat 5000 x 250 x 8 mm	162508500081
Anti-slip mat 5000 x 500 x 8 mm	165008500081
Anti-slip mat 10000 x 1250 x 8 mm	161250810081

Antirutschmatte Achteck

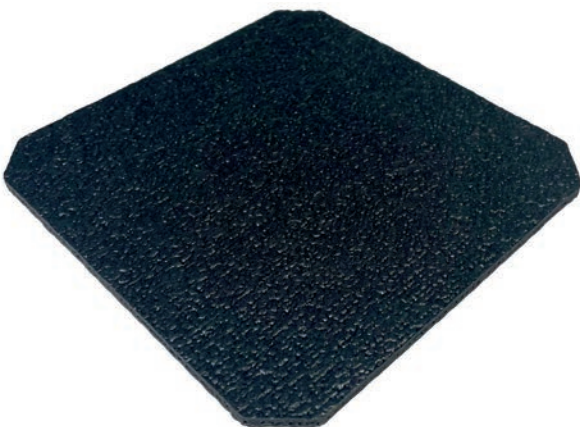

Technische Daten

- > material: PES/glass yarn fabric
- > material thickness: 4.5 mm
- > coefficient of sliding friction $\mu = 0.7 \mu$
- > colour: black
- > shape-retaining, stable and hard-wearing
- > double-sided anti-slip coating

Designation	Item number
Anti-slip mat octagon 150 x 150 mm	1601001

Lashing strap retractor



black powder-coated



Stainless steel version

Technical data

- > for strap widths up to 50 mm
- > material: steel, black powder-coated or stainless steel

Designation	Item number
Lashing strap retractor, steel version	160020000000
Lashing strap retractor, stainless steel version	160020000030

Longitudinal bar 6030/3009

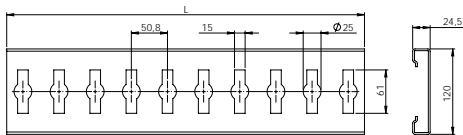
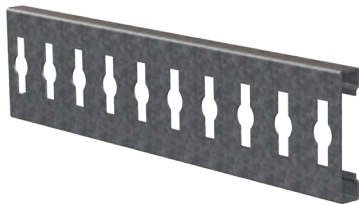

Technical data

- > material: steel, hot-dip galvanized

Designation	Item number
Longitudinal bar 6030/3009 steel 3500 mm	226030093500

Special feature: Combined with a decking beam, it is possible to achieve high blocking forces on a semi-trailer / curtainsider. Lashing straps can also be used with appropriate fittings.

Adapter belt as parking device



Technical data

- > adapter strap for hanging up / storage of short ends or intermediate wall closures on side walls and tarpaulin frame
- > strap width: 25 mm
- > colour: red
- > with reversing loop and tarpaulin frame hooks

Designation	Item number
Special belt SE parking device for batten	1250705

Aluminum parting wall lock 7453

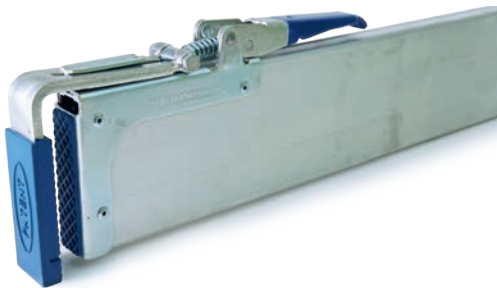

Technical data

- > with folded steel end piece
- > application range: 2,400 mm – 2,700 mm
- > max. blocking force: BC 400 daN for uniform area loading up to 2,700 mm

Designation	Item number
Parting wall lock alum. 2400-2700 mm standard	237453000020

Steel parting wall lock S4



Technical data

- > application range: 1,920 mm – 2,720 mm
- > equipped with protective caps in the end pieces from inside and outside

Designation	Item number
Parting wall lock steel 1,920-2,720 mm	237430000012

Complete end piece

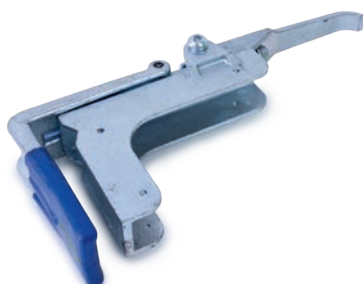

Technical data

- > for intermediate wall lock 237452900020

Designation	Item number
Parting wall lock end piece assembly	237450000012

Double-deck system curtainsider



Scan QR code
and watch video

[You can find the
video here](#)



- › optimal utilisation of the cargo volume by creating 33 Euro pallet positions on the 2nd loading level, goods of different heights can be loaded without any problems
- › simple self-explanatory operation
- › height-adjustable in 50 mm increments
- › Unused support beams are parked between the stanchions.
- › longitudinal locking of the supporting beams to stabilise the vehicle body
- › The loading surface for the pallets is approx. 15 mm below the upper edge of the longitudinal beam and thus serves as a pallet stop. No slipping out of the pallets into the tarpaulin.
- › positive cargo securing is also possible with axle load-optimised partial loading by means of additional load-bearing beams or longitudinal beams
- › The maximum load capacity of the positive fit with uniform loading is 500 daN. A prerequisite is sufficient body strength (Code XL certificate for standard semi-trailers).
- › Total loading capacity of the 2nd loading level is usually 6,000 kg to 11,000 kg (depending on the trailer manufacturer's specifications).
- › max. pallet weight 275 – 500 kg
- › Additional diagonal lashing is possible.
- › DDS-CS plank pockets can be installed in the double-decking pillars and adjusted in height.

Note: The maximum load capacity of the 2nd loading level is specified by the manufacturer of the semi-trailer or vehicle. A subsequent installation of the system not approved by the manufacturer can lead to the loss of the XL certificate and/or the factory guarantee.

Double-deck system curtainsider with 3 pairs of stanchions

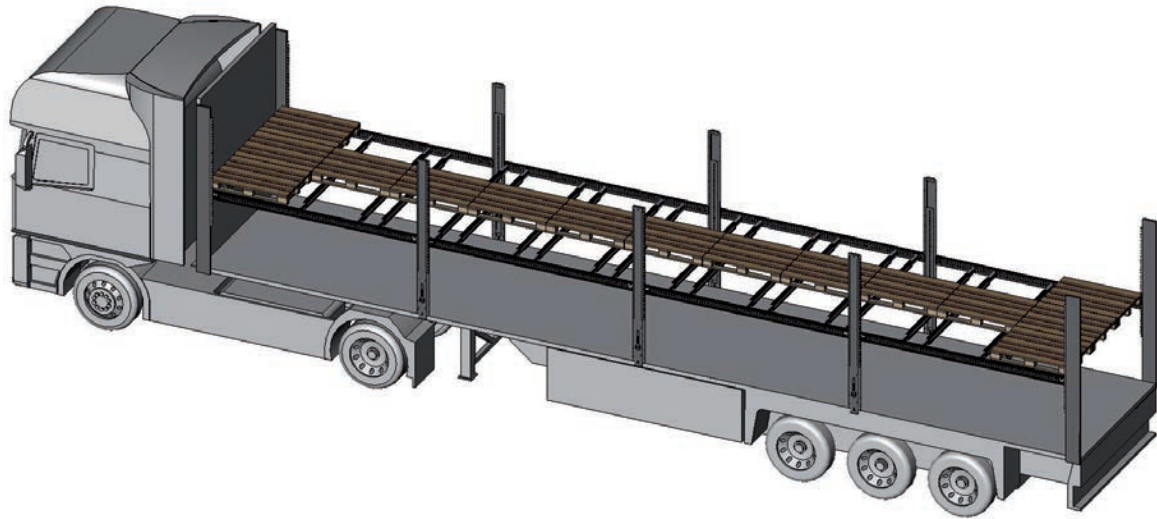

Double-deck system curtainsider with 5 pairs of stanchions

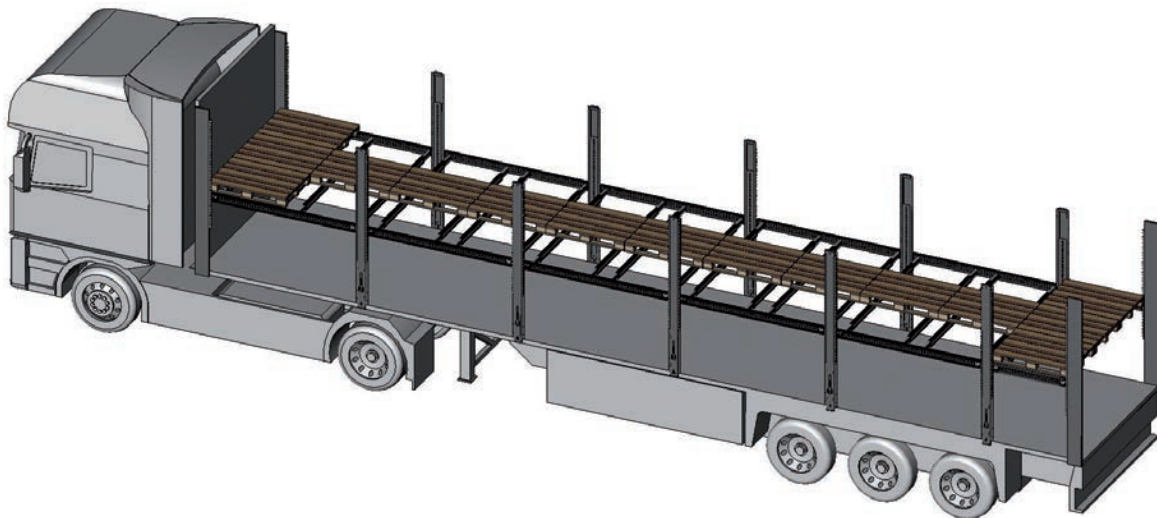

Longitudinal bar for double-deck curtainsider system



Technical data

- > material: steel, KTL-coated
- > load capacity for 2,300 kg/stanchion field
- > max. load 1,150 kg
- > profile length of 3,120 mm for application range of 3,145...3,170 mm +/- 5
- > end pieces movable by 20 mm on both sides

Attention: When placing your order, please specify the profile length and version.

Aluminum carrier bar for double-deck curtainsider system

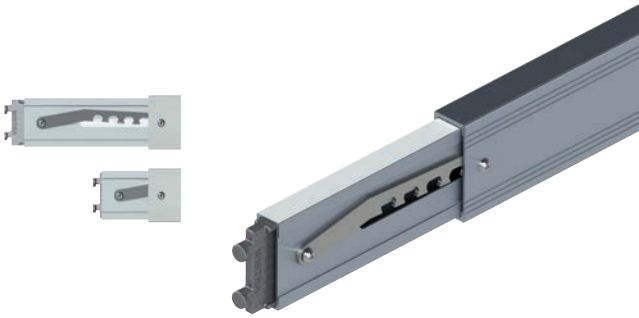

Technical data

- > size: 40 mm x 105 mm
- > complete pull-out on both sides with length adjustment
- > load capacity for 500 kg/Euro pallet
- > max. load 1,000 kg
- > profile length of 2,000 mm for application range of 2,220...2,510 mm +/- 5
- > end pieces movable by 20 mm on both sides

WISTRA Accessories

Bow base support



Item number: 228010001

Keyhole bar



Item number: 237453000020

End fitting, keyhole



Item number: 140000801000
LC: 10 kN

FIX STRAP – simplifies the use of lashing straps



Simple but ingenious solution

With the "FIX STRAP" load securing system, the lashing strap hangs on rails directly under the roof of the semi-trailer with the aid of rubber ropes. The hook on one side is pulled down and fixed to a lashing point.

Thanks to the rubber rope, the hook remains fixed. After loading, the lashing strap is pulled over the cargo, just like a normal lashing strap. During unloading, the ratchet is opened and the rubber ropes pull the lashing strap under the ceiling of the hold. This makes unloading and loading easier.

Since the rubber ropes with holders run on rails on the roof of the semi-trailer, you can simply pull the lashing strap to where it is needed.



Rated best in regard to work safety*



8 loads per week gives a payback period of 5 weeks



Meets the loading requirements of the EU

*HSE Health and Safety Executive, UK

Advantages:

- > climbing onto the loading area and cargo to apply a lashing strap is avoided
- > throwing of lashing straps over the cargo is avoided
- > time saving during loading and unloading due to flexible positioning of the system on the rails
- > simple and safe
- > FIX STRAP uses the same suspension system as the FIX ROAD load securing system, making it easy to switch.

Available as a set

Designation	Item number
Belt lift system SET 14.4 m 12 bungees	160400
Belt lift system SET 7.2 m 6 bungees	160401
Belt lift system SET for fixed installation for 1 belt	160402

Accessories / spare parts

Designation	Item number
FIX-Mini 0,4 x 2,8 m	160200
FIX-Bungee Fixed sys. d19/375 colour 8 mm	160211
FIX-Slide	160220
FIX-Bungee sys. d19/375 colour 8 mm	160210

FIX ROAD



The easy way of securing cargo

28

There is a simple solution with which you can avoid the time-consuming and often complicated securing of cargo. "FIX ROAD" is a cargo securing system that is quick, safe and easy to use. "FIX ROAD" consists of a hard-wearing tarpaulin, which is attached beneath the roof of the semi-trailer with rubber ropes. The tarpaulin, which runs on rails, can be quickly and easily pulled over the cargo. There is no longer any need to climb onto the cargo to attach straps and edge protection. The tarpaulin covers the transported goods evenly and is then tensioned with the aid of integrated lashing straps.

In accordance with EU Directives

"FIX ROAD" is not only user-friendly, it also protects the cargo. It is suitable for securing most types of goods, from rolls, pallets, bales, web and sheet goods to sacks and octabins. "FIX ROAD" makes securing the cargo easier, especially for bulky and cargo of different sizes. Because the tarpaulin is attached to the roof, the semi-trailer is ready for loading at all times. "FIX ROAD" complies with the applicable EU safety guidelines (VDI 2700 / cargo securing on road vehicles and DIN standards EN 12195-2 / lashing straps made of synthetic

fibres). The "FIX ROAD" tarpaulin has woven reinforcements and hemmed-in safety straps. It has a permissible LC of 2,500 daN.

With "FIX ROAD", you no longer need to climb onto the cargo to secure it. The tarpaulin can be easily and quickly pulled over the cargo. After all, it only weighs just over 40 kg. Bulky cargo can be secured quickly and easily with the "FIX ROAD" tarpaulin because it covers the cargo evenly. Time-consuming considerations on how to secure the transported goods are not necessary. With "FIX ROAD", the lashing straps are simply tensioned downwards into the lashing points on the bed.



Many advantages

- › quick and easy to use
- › soft and easily mouldable, even in cold and rough weather
- › hard-wearing material with UV protection
- › does not damage the goods
- › protects against rain and dirt
- › makes edge protection superfluous
- › low weight (a medium-sized tarpaulin weighs about 40 kg)
- › long service life even under difficult conditions
- › advertising material can be printed or sewn on
- › saves time when securing the cargo
- › fits different types of goods
- › enables a longer and/or wider protective tarpaulin (for better protection against e.g. rain)
- › DEKRA-approved



patented



tested and approved
by DEKRA



high sustainability
and long lifespan



The WISTRA sprinter on tour



31

QR-Code er
und den WI
bequem be

Daken Velvet 1000 tool box

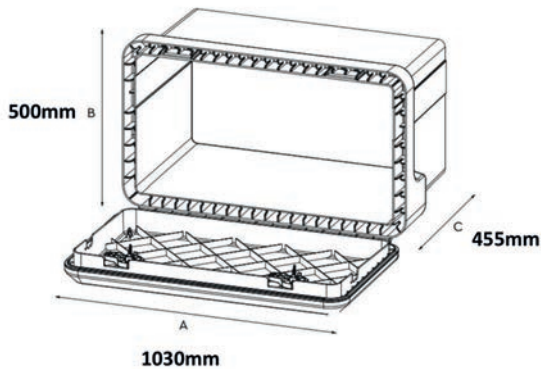

Technical data

- > material: plastic (polypropylene)
- > colour: black
- > size: 1,030 x 500 x 455 mm
- > made by injection molding
- > reinforced structure for high durability and long lifespan
- > lock with lock cylinder for maximum safety against theft and abuse
- > PVC inner seal against dust and water ingress
- > smooth inner surface
- > high-grade plastic materials with high resistance to UV rays, fire, lubricating oils, carbon hydrogen, high and low temperatures
- > continuous hinge
- > volume: approx. 155.5 l, weight: 13 kg, payload: max. 70 kg
- > 6 keys
- > made in Italy
- > ECE certification as lateral collision protection
- > TÜV RHEINLAND approvals: Resistance to water and dust

Designation	Item number
Tool box Daken Velvet 1000	160502

Daken Just 500-R tool box

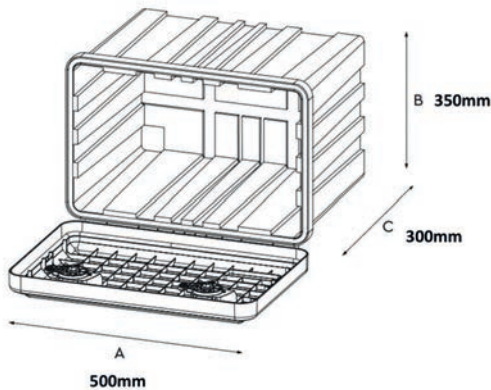

Technical data

- > material: plastic (polypropylene)
- > colour: black
- > size: 500 x 350 x 300 mm
- > lockable pressure lock
- > dust and splash-proof
- > shockproof outer shape
- > UV stable
- > volume: approx. 30.5 l
- > weight: 3.6 kg
- > ECE certification as lateral collision protection
- > TÜV RHEINLAND approvals: Resistance to water and dust

Designation	Item number
Tool box Daken Just 500-R	160503

Daken universal holder

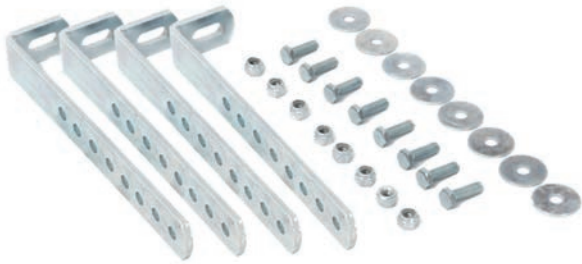

Technical data

The hot dip galvanized universal holder for Daken Velvet Just tool boxes is used for fastening underneath a loading surface on the vehicle.

- > for Daken Velvet Just tool box
- > material: 6 mm
- > weight: 1.7 kg
- > made in Italy

Designation	Item number
Daken universal holder for Daken	160505

Daken Blackit 2 drawbar box

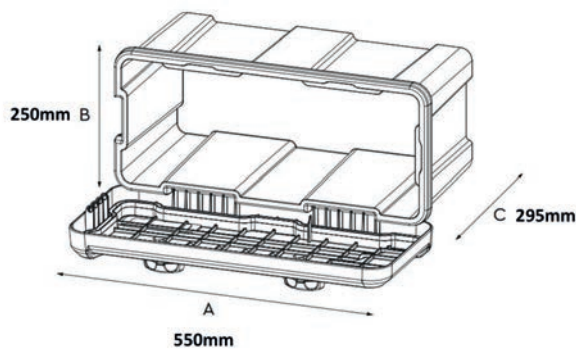

Technical data

- > material: plastic (polypropylene)
- > colour: grau
- > size: 550 x 250 x 295 mm
- > made by injection molding
- > reinforced structure for high durability and long lifespan
- > 2 locks with lock cylinder for maximum safety against theft and abuse
- > optimal for mounting on the drawbar of a trailer
- > overlapping lid and PVC inner gasket against dust and water ingress
- > high-grade plastic materials with high resistance to UV rays, fire, lubricating oils, carbon hydrogen, high and low temperatures
- > stable hinges
- > volume: approx. 23 23 l
- > weight: 2.8 kg
- > 4 keys
- > made in Italy
- > ECE certification as lateral collision protection
- > TÜV RHEINLAND approvals: Resistance to water and dust

Designation	Item number
Tool box Daken Blackit 2 drawbar box	160504

Daken square drawbar holder

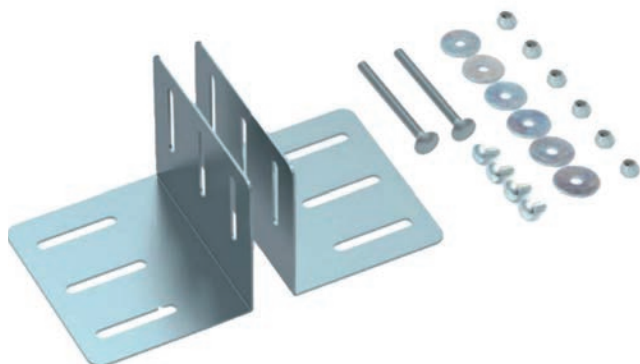

Technical data

The cold galvanized square handle bar holder for Daken Blackit 2 tool boxes are used to attach tool boxes on the drawbar.

- > for Daken Blackit 2 drawbar box
- > material thickness: 2 mm
- > weight: 1.2 kg
- > made in Italy

Designation	Item number
Daken square drawbar holder for Daken	160506

Daken V-drawbar holder



Technical data

The cold galvanized V-drawbar holder for Daken Blackit 2 tool boxes are used to attach to a V-drawbar.

- > for Daken Blackit 2 drawbar box
- > material thickness: 6 mm
- > weight: 0.7 kg
- > made in Italy

Designation	Item number
Daken V-drawbar holder for Daken	160507

Daken front wall holder

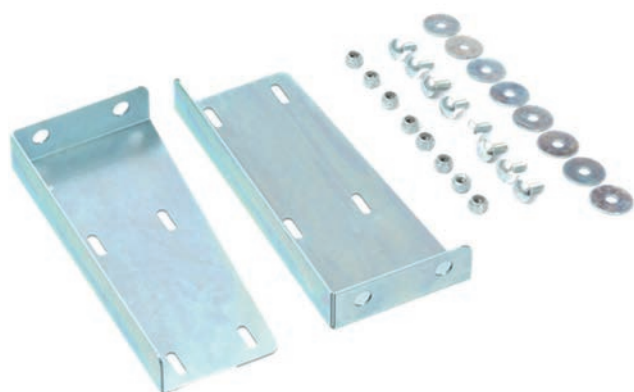

Technical data

The cold galvanized front wall bracket for Daken Blackit 2 tool boxes attaches to a trailer.

- > for Daken Blackit 2 drawbar box
- > material thickness: 2 mm
- > weight: 1.6 kg
- > made in Italy

Designation	Item number
Daken front wall bracket for Daken	160508

Daken Strike Feuerlöscherkasten



Technical data

- > material: plastic (polypropylene)
- > colour: rot, schwarz
- > size: 287 x 600 x 220 mm
- > made by injection molding
- > can be used for 6 kg fire extinguishers with a diameter from 150 to 170 mm
- > installation can be horizontal or vertical
- > PVC inner seal against dust and water ingress with viewing window (with OR seal for optimal water resistance)
- > 2 ergonomic nylon closures
- > blocking kit with bayonet lock consisting of: Nylon clamping ring and PVC locking spring with 4 holes
- > lockable by padlock or sealable for maximum security against theft and abuse
- > stable hinges
- > weight: 1.9 kg
- > made in Italy

The fire extinguisher is not included.

Designation	Item number
Daken Strike fire extinguisher box 6 kg for self-installation (box / cover / rubber)	160510



Top seller

Adjustable round shoring beam aluminum

More on page 56



**Cargo securing for
box trucks**

Aluminum track with pins 4710

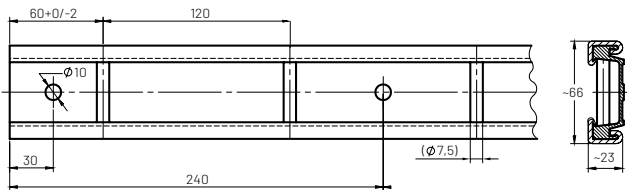

Technical data

- > with rubber protection
- > width: 66 mm (incl. protective profile)
- > height: 23 mm (incl. protective profile)
- > rod diameter: 8 mm
- > hole pitch: Ø 10 mm, grid: 240 mm
- > pin: Ø 7.5 mm, grid: 120 mm
- > aluminum, untreated

Designation	Item number
Track with pins type 4710 6,000 mm with rubber protection	21471020-6000
Track with pins type 4710 3,000 mm with rubber protection	21471020-3000
Track with pins type 4710 2,000 mm with rubber protection	21471020-2000

End cap for track with pins 4710



Technical data

- > material: plastic
- > colour: black

Designation	Item number
Protective wedge for track with pins type 4710	212106661540

Anchor combi lashing track 3009

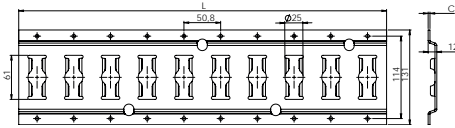
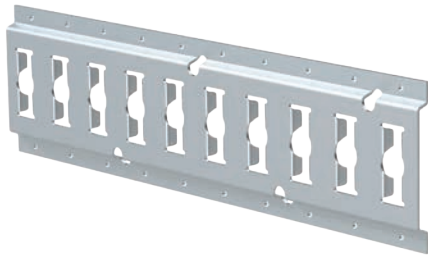

Technical data

- > material: steel, galvanized / aluminum / stainless steel
- > length: 3,048 mm +/- 5
- > hole diameter: 25 mm
- > material thickness: 2.5 mm / 3.0 mm

Designation	Item number
Anchor combi lashing track type 3009 2.5 mm steel 3,048 mm	213009250012
Anchor combi lashing track type 3009 3.0 mm steel 3,048 mm	213009300012
Anchor combi lashing track type 3009 3.0 mm aluminium 3,048 mm	213009300020
Anchor combi lashing track type 3009 2.5 mm stainless steel 3,048 mm	213009250030

Combi lashing track 3008

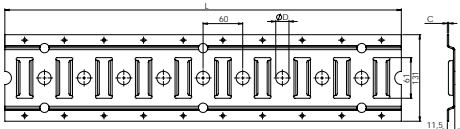
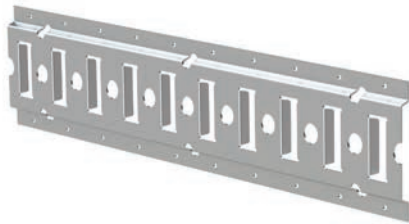

Technical data

- > material: steel, galvanized / aluminum / stainless steel
- > length: 3,000 mm +/- 5
- > hole diameter: 20 mm / 25 mm
- > material thickness: 2.5 mm / 3.0 mm

Designation	Item number
Combi lashing track type 3008 2.5 mm steel 3,000 mm Ø 20 mm	213008252012
Combi lashing track type 3008 2.5 mm stainless steel 3,000 mm Ø 20 mm	213008252030
Combi lashing track type 3008 2.5 mm steel 3,000 mm Ø 25 mm	213008252512
Combi lashing track type 3008 3.0 mm aluminium 3,000 mm Ø 20 mm	213008302020

Anchor combi lashing track, flat 3109

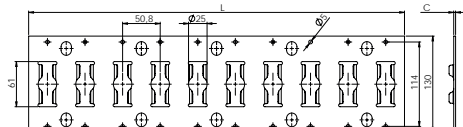
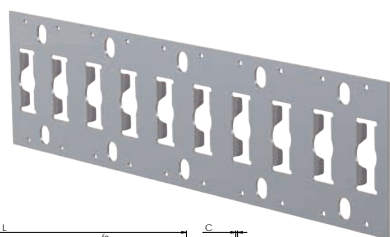

Technical data

- > material: steel, galvanized / stainless steel
- > length: 3,048 mm +/- 5
- > hole diameter: 25 mm
- > material thickness: 2.5 mm

Designation	Item number
Anchor combi lashing track type 3109 2.5 mm steel 3,048 mm	213109250012
Anchor combi lashing track type 3109 2.5 mm stainless steel 3,048 mm	213109250030

Anchor combi lashing track 3108

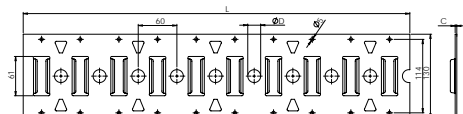
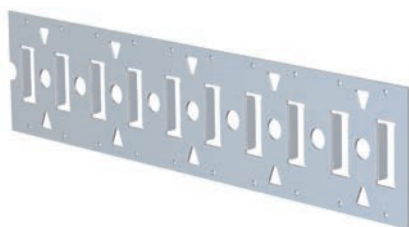

Technical data

- > material: steel, galvanized / stainless steel
- > length: 3,000 mm +/- 5
- > hole diameter: 20 mm
- > material thickness: 2.5 mm

Designation	Item number
Anchor combi lashing track type 3108 2.5 mm stainless steel 3,000 mm Ø 20 mm	213108252030

End cap for combi and anchor combi lashing tracks

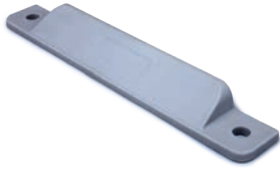

Technical data

- > for combi and anchor combi lashing tracks Type 3008 / 3009

Designation	Item number
Protective wedge for combi / anchor combi lashing track	212109951240

Keyhole lashing track 1803, horizontal

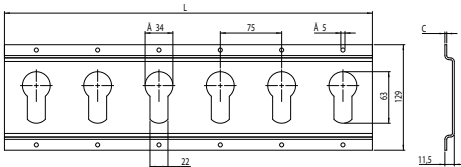
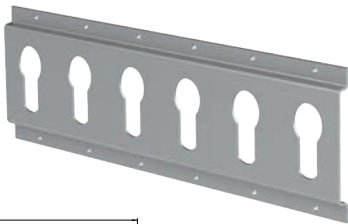

Technical data

- > material: steel, galvanized
- > length: 3,000 mm +/- 5
- > material thickness: 2.3 mm

Designation	Item number
Keyhole lashing track type 1803 horizontal	211803200852

Keyhole lashing track 1803, vertical

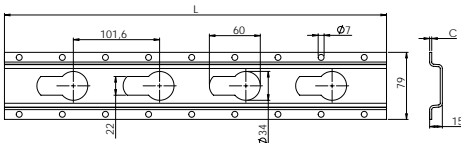
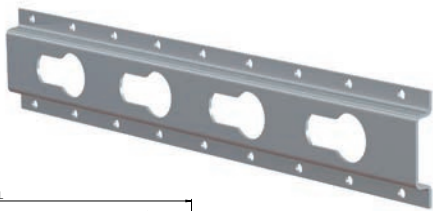

Technical data

- > material: steel, galvanized
- > length: 3,000 mm +/- 5
- > material thickness: 2.5 mm

Designation	Item number
Keyhole lashing track type 1803 vertical	211803200152

Round hole lashing track 1805

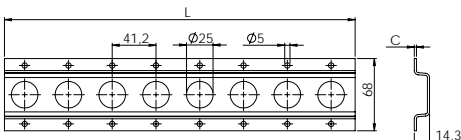
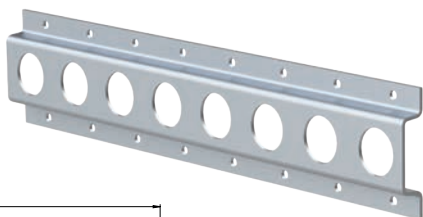

Technical data

- > material: steel, galvanized
- > length: 3,048 mm +/- 3
- > hole diameter: 25 mm
- > material thickness: 2.0 mm

Designation	Item number
Round hole lashing track type 1805 2.0 mm steel 3,048 mm Ø 25 mm	211805122512

Round hole lashing track 1806 with cut-out

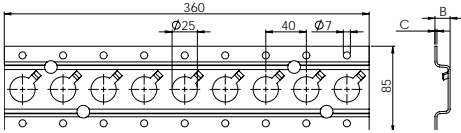
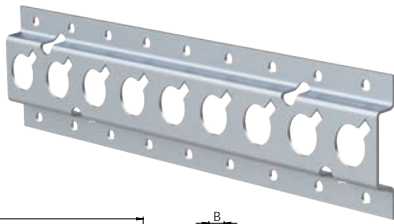

Technical data

- > material: steel, galvanized
- > length: 3,000 mm +/- 5
- > hole diameter: 25 mm
- > material thickness: 2.5 mm

Designation	Item number
Round hole lashing track type 1806 2.5 mm steel 3,000 mm Ø 25/12 mm	211806251212

End cap for round hole lashing tracks



Technical data

- > for round hole lashing track Type 1805 / 1806

Designation	Item number
End cap for round hole lashing track	212106501240

Round hole lashing track for the floor

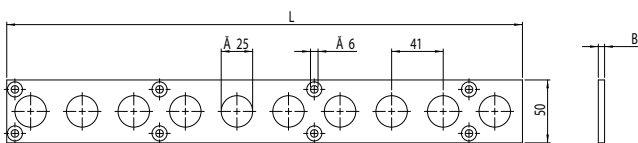

Technical data

- > material: steel
- > length: 2,990 mm +/- 5
- > hole diameter: 25 mm
- > material thickness: 5.0 mm

Designation	Item number
Round hole lashing track type 3004 5.0 mm steel 2,990 mm Ø 25 mm	213004502512

Round hole lashing track for the floor

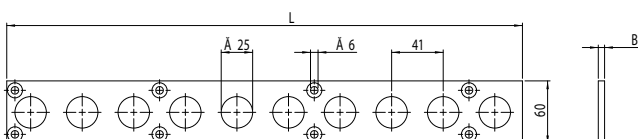

Technical data

- > material: aluminum
- > length: 2,990 mm +/- 5
- > hole diameter: 25 mm
- > material thickness: 6.0 mm

Designation	Item number
Round hole lashing track type 3004 6.0 mm aluminium 2,990 mm Ø 25 mm	213004602520

Single airline guide track for double-deck loading

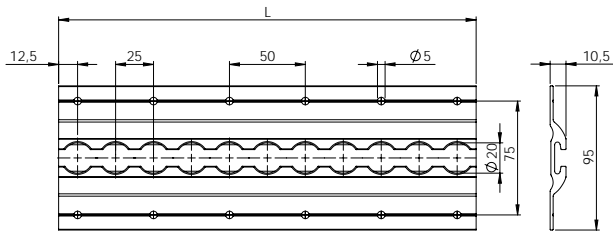
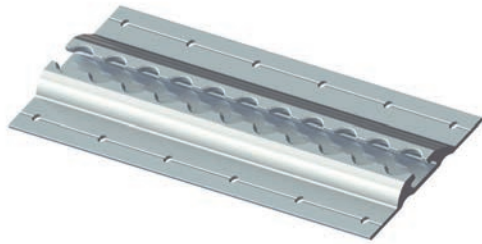

Technical data

- > material: aluminum, untreated
- > incl. mounting holes
- > length: 1,975 mm +/- 5
- > hole diameter: 20 mm
- > hole pattern: 25.0 mm

Designation	Item number
Airline lashing track type 5001 for double-deck system 1,975 mm bare	21500120-1975

Tandem airline guide track for double-deck loading

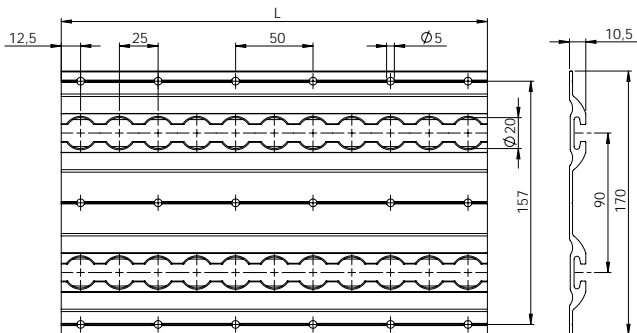

Technical data

- > material: aluminum, untreated
- > incl. mounting holes
- > length: 1,975 mm +/- 5
- > hole diameter: 20 mm
- > hole pattern: 25.0 mm

Designation	Item number
Airline lashing track type 5021 for double-deck system 1,975 mm tandem bare	21502120-1975

Steel airline guide track 5001

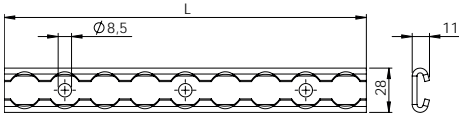

Technical data

- > material: steel, galvanized
- > incl. mounting holes
- > length: 2,413 mm +/- 5
- > hole diameter: 20 mm
- > hole pattern: 25.4 mm
- > material thickness: 3.0 mm

Designation	Item number
Airline lashing track type 5001 steel 2,400 mm	215001312012

Anchor combi lashing track, vertical

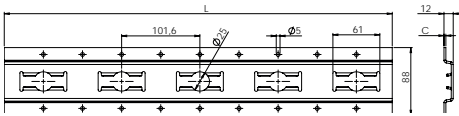
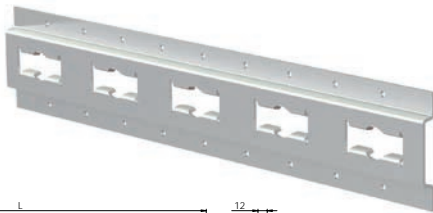

Technical data

- > material: steel, galvanized
- > length: 2,438 mm +/- 5
- > hole diameter: 25 mm
- > material thickness: 2.5 mm

Designation	Item number
Anchor combi lashing track type 2010 2.5 mm steel 2,400 mm	212010250812

End fitting 821 for anchor combi lashing tracks



Technical data

- > LC (lashing capacity): 1,000 daN
- > ring diameter (inner): 33 mm

Designation	Item number
End fitting type 821 for anchor combi lashing track	140000082100

End fitting 822 for anchor combi lashing tracks



Technical data

- > LC (lashing capacity): 1,000 daN
- > ring diameter (inner): 34 mm

Designation	Item number
End fitting type 822 for anchor combi lashing track	140000082200

WTR 1500-826 Ratchet lashing strap



Technical data

- > two-part - SE 1.0 m + LE 4.0 m
- > according to EN 12195-2
- > LC 750 daN with straight tension
- > STF 210 daN
- > with end fitting **826** (for combi and anchor combi lashing tracks)
- > strap: 50 mm, green

Designation	Item number
Ratchet lashing strap WTR 1500 fitting 826 for anchor tracks SE 1.0 + LE 4.0 green	1504273
Ratchet lashing strap WTR 1500 fitting 826 for anchor tracks SE 0.5 + LE 4.5 green	1504252

WTR 1500-828 Ratchet lashing strap



Technical data

- > two-part - SE 0.5 m + LE 4.5 m
- > according to EN 12195-2
- > LC 750 daN with straight tension
- > STF 210 daN
- > with end fitting **828** (for keyhole lashing tracks)
- > strap: 50 mm, green

Designation	Item number
Ratchet lashing strap WTR 1500 fitting 828 for keyhole tracks SE 0.5 + LE 4.5 green	1504370

WTK 1000-826 cam buckle strap

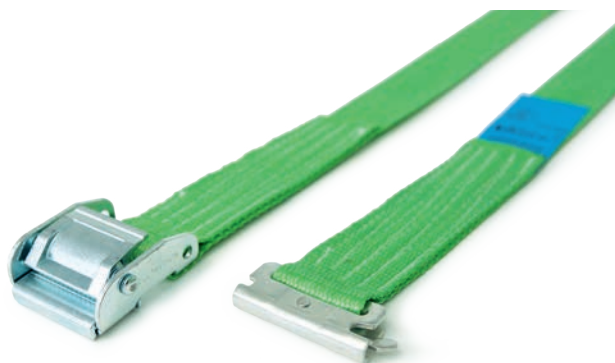

Technical data

- > two-part - SE 1.0 m + LE 4.0 m
- > according to EN 12195-2
- > LC 500 daN with straight tension
- > with end fitting **826** (for combi and anchor combi lashing tracks)
- > strap: 50 mm, green

Designation	Item number
Cam buckle strap WTK 1000 fitting 826 for anchor tracks SE 1.0 + LE 4.0 green	1503826

WTK 1000-828 cam buckle strap



Technical data

- > two-part – SE 1.5 m + LE 2.5 m
- > according to EN 12195-2
- > LC 500 daN with straight tension
- > with end fitting **828** (for keyhole lashing tracks)
- > strap: 50 mm, blue

Designation

Cam buckle strap 1000 fitting 828 for keyhole tracks
SE 1.5 + LE 2.5 blue

Item number

1501346



Shoring beam COMBI-BEAM 1858



Technical data

The COMBI-BEAM 1858 + 18z59 is a WISTRA development with a particular focus on user-friendliness and gentle use in pressure-sensitive vehicle areas.

- > range of application 2,450 – 2,500 mm
- > support tube made of aluminum
- > 1858 version equipped with black PVC hose
- > 1859 without PVC hose
- > with end piece 1858 for combi or anchor combi lashing tracks
- > with WIS product sticker or with customer-specific product sticker



Designation	Item number
Shoring beam Combi-Beam type 1858 with coating WIS sticker	221858001-2450
Shoring beam Combi-Beam type 1858 with coating var. stickers	221858999-2450

Designation	Item number
Shoring beam Combi-Beam type 1859 WIS sticker	221859001-2450
Shoring beam Combi-Beam type 1859 var. stickers	221859999-2450

Advantages	for the user	for the means of transport / the cargo	compared to similar products
In conjunction with non-slip materials, cargo with a weight of up to 2,000 kg can be secured in the direction of travel using one Combi-Beam	✓	✓	✓
Easy telescoping as standard up to 70 mm	✓		✓
No protruding operating controls over its entire range	✓	✓	✓
Silent design with plastic centring piece	✓		✓
Version 1858: Support tube with PVC coating for a pleasant user feel, even at cool outside temperatures, and as protection for the cargo	✓	✓	✓
The combination pins on both sides snap into the combi lashing track	✓	✓	✓
The combination pins are gentle on the material inside the lashing track	✓	✓	✓
When the Combi-Beam is inserted by the user, no simultaneous pressure is required	✓	✓	✓
The combination pins are prevented from slipping out by a locking mechanism activated by applying pressure to the side panel	✓	✓	✓
Thanks to the locking mechanism in the combi lashing track, the system does not damage the transport vehicle	✓	✓	✓
High-quality product identification glued to the telescope	✓		✓

WISTRA PEN-BEAM

made of aluminum or steel

Functionality

The **WISTRA PEN-BEAM** is equipped with an innovative gas pressure spring and defined pressure on the vehicle body over the entire telescope range. The special snap-in function in the telescopic tube is for ergonomic use.

All PEN-BEAM variants can optionally be equipped with PVC coating. In addition, all versions can be customized according to the interior vehicle dimensions and the type of lashing track.



Steel WISTRA PEN-BEAM



Technical data

- > support tube diameter: 42 mm
- > blocking force BC 500 daN with uniform surface load

- > with PVC coating in black
- > possible application range: 2.480 mm (+/- 25 mm)

Designation	Item number
Shoring beam type 1873 PEN-BEAM steel 44	221873004412-2480
Shoring beam type 1873 PEN-BEAM steel 44 with coating	221873004412Ü-2480

Version: 44
19/24/33 mm combination pin

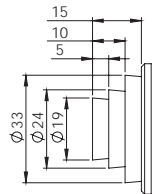

Aluminium WISTRA PEN-BEAM



Technical data

- > support tube diameter 42 mm
- > blocking force BC 400 daN with uniform surface load

- > with PVC coating in black
- > for vehicle interior dimensions 2.480 mm (+/- 25 mm)

Designation	Item number
Shoring beam type 1871 PEN-BEAM aluminium 44	221871004420-2480
Shoring beam type 1871 PEN-BEAM aluminium 44 with coating	221871004420Ü-2480

Version: 44
19/24/33 mm combination pin

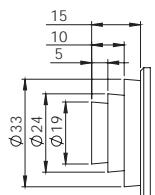

Steel shoring beam



Technical data

- > support tube diameter: 42 mm
- > blocking force BC 500 daN with uniform surface load

- > with PVC coating in blue
- > possible application range: 2440 mm - 2520 mm

Designation	Item number
Shoring beam type 1817 steel with pin 09	221817000912
Shoring beam type 1817 steel with pin 09 with coating	221817000912Ü

Version: 09
19 mm pin

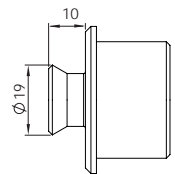

Designation	Item number
Shoring beam type 1817 steel with pin 24	221817002412
Shoring beam type 1817 steel with pin 24 with coating	221817002412Ü

Version: 24
24 mm pin

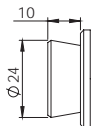

Designation	Item number
Shoring beam type 1817 steel with pin 44	221817004412
Shoring beam type 1817 steel with pin 44 with coating	221817004412Ü

Version: 44
19/24/33 mm combination pin

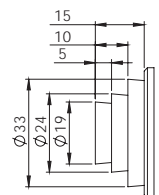

Designation	Item number
Shoring beam type 1817 steel with pin 45	221817004512
Shoring beam type 1817 steel with pin 45 with coating	221817004512Ü

Version: 45
19/24 mm pin for rod rail

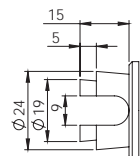

Aluminium shoring beam

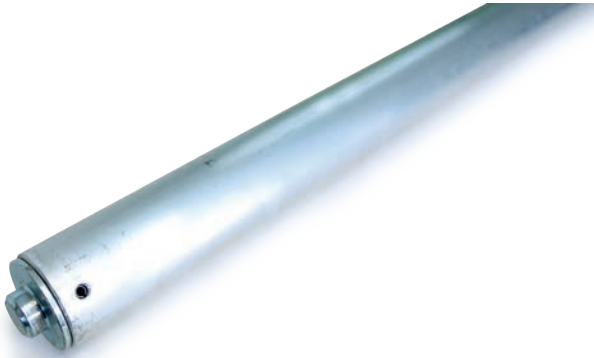

Technical data

- > support tube diameter: 42 mm
- > blocking force BC 400 daN with uniform surface load

- > with PVC coating in blue
- > possible application range: 2440 mm - 2520 mm

Designation	Item number
Shoring beam type 1817 aluminium with pin 09	221817000920
Shoring beam type 1817 aluminium with pin 09 with coating	221817000920Ü

Version: 09
19 mm pin

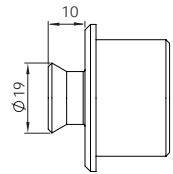

Designation	Item number
Shoring beam type 1817 aluminium with pin 24	221817002420
Shoring beam type 1817 aluminium with pin 24 with coating	221817002420Ü

Version: 24
24 mm pin

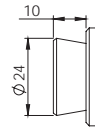

Designation	Item number
Shoring beam type 1817 aluminium with pin 44	221817004420
Shoring beam type 1817 aluminium with pin 44 with coating	221817004420Ü

Version: 44
19/24/33 mm combination pin

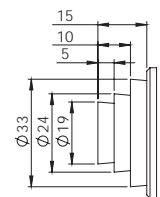

Designation	Item number
Shoring beam type 1817 aluminium with pin 45	221817004520
Shoring beam type 1817 aluminium with pin 45 with coating	221817004520Ü

Version: 45
19/24 mm pin for rod rail

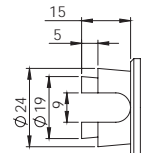

Steel shoring beam, adjustable



Technical data

- > support tube diameter: 42 mm
- > blocking force BC 500 daN with uniform surface load

- > with PVC coating in blue
- > possible application range: 2.235 mm - 2.685 mm

Designation	Item number
Shoring beam type 1811 steel with pin 09	221811000912
Shoring beam type 1811 steel with pin 09 with coating	221811000912Ü

Version: 09
19 mm pin

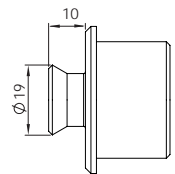

Designation	Item number
Shoring beam type 1811 steel with pin 24	221811002412
Shoring beam type 1811 steel with pin 24 with coating	221811002412Ü

Version: 24
24 mm pin

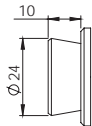

Designation	Item number
Shoring beam type 1811 steel with pin 44	221811004412
Shoring beam type 1811 steel with pin 44 with coating	221811004412Ü

Version: 44
19/24/33 mm combination pin

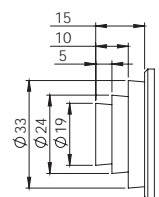

Designation	Item number
Shoring beam type 1811 steel with pin 45	221811004512
Shoring beam type 1811 steel with pin 45 with coating	221811004512Ü

Version: 45
19/24 mm pin for rod rail

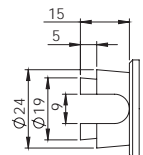

Aluminum shoring beam, adjustable



Technical data

- > support tube diameter: 42 mm
- > blocking force BC 400 daN with uniform surface load

- > with PVC coating in blue
- > possible application range: 2.235 mm - 2.685 mm

Designation	Item number
Shoring beam type 1808 aluminium with pin 09	221808000920
Shoring beam type 1808 aluminium with pin 09 with coating	221808000920Ü

Version: 09
19 mm pin

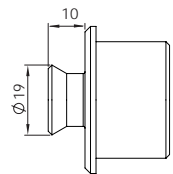

Designation	Item number
Shoring beam type 1808 aluminium with pin 24	221808002420
Shoring beam type 1808 aluminium with pin 24 with coating	221808002420Ü

Version: 24
24 mm pin

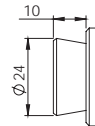

Designation	Item number
Shoring beam type 1808 aluminium with pin 44	221808004420
Shoring beam type 1808 aluminium with pin 44 with coating	221808004420Ü

Version: 44
19/24/33 mm combination pin

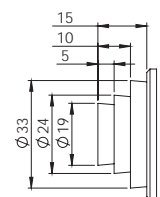

Designation	Item number
Shoring beam type 1808 aluminium with pin 45	221808004520
Shoring beam type 1808 aluminium with pin 45 with coating	221808004520Ü

Version: 45
19/24 mm pin for rod rail

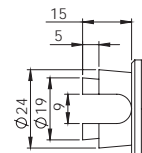

“Power” – Aluminum shoring beam

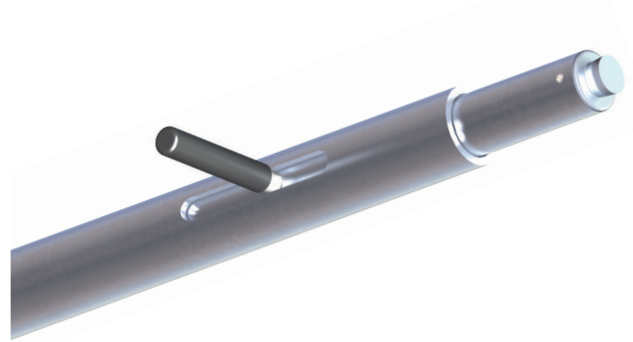
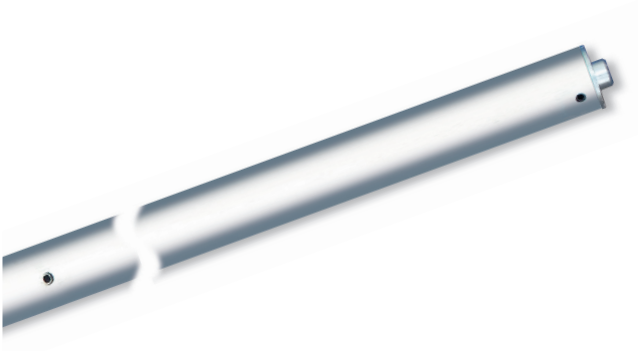

Technical data

- > support tube diameter: 50 mm
- > blocking force BC 700 daN with uniform surface load

- > “ergo” version – the additional handle facilitates the use of the shoring beam
- > for vehicle interior dimensions 2,400 – 2,480 mm

Designation	Item number
Power shoring beam type 1850 aluminium with pin 09	221850150920
Power shoring beam type 1854 aluminium with pin 09	221854010920-2430

Version: 09
19 mm pin

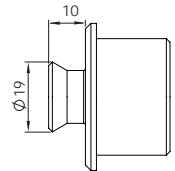

Square steel shoring beam

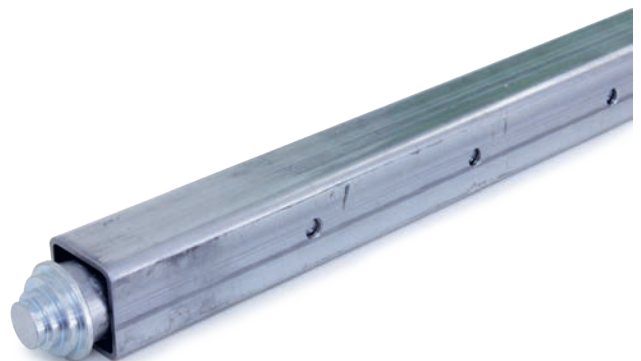
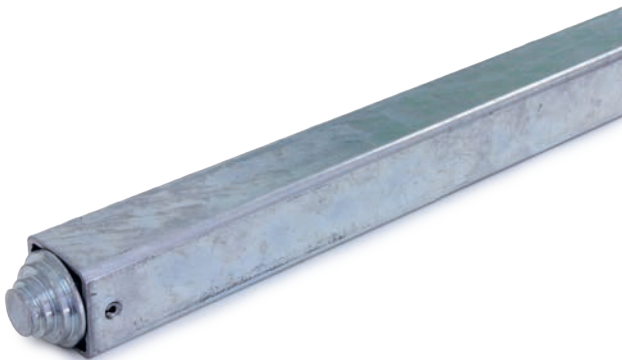

Technical data

- > support tube: 41 x 41 mm
- > blocking force BC 500 daN with uniform surface load

- > adjustable
- > possible application range: 2.440 mm - 2.520 mm

Designation	Item number
Square shoring beam type 1827 steel with pin 44	221827004412
Square shoring beam type 1812 steel with pin 44	221812004412

Version: 44
19/24/33 mm combination pin

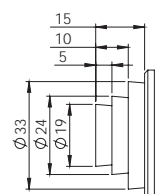

Aluminum cargo bar 1842, 1843, 1845



Technical data

- > support tube diameter: 42 mm
- > operating element: lever with rack
- > equipped with non-slip rubber feet on both sides
- > with spring system

Designation	Item number
Cargo bar aluminium type 1842 2,350-2,720 mm	221842010020TW
Cargo bar aluminium type 1843 2,350-2,720 mm	221843010020TW
Cargo bar aluminium type 1844 2,500-2870 mm	221844010020TW
Cargo bar aluminium type 1845 2,650-3,020 mm	221845010020TW

Aluminum cargo bar 1867



Technical data

- > support tube diameter: 38 mm
- > operating element: lever with rack
- > equipped with non-slip rubber feet on both sides
- > with spring system

Designation	Item number
Cargo bar aluminium type 1867 2,260-2,630 mm	221867010020TW

Steel cargo bar 1840



Technical data

- > support tube: 35 x 35 mm
- > operating element: lever with hole grid in telescopic tube
- > equipped with non-slip rubber feet on both sides
- > with spring system

Designation	Item number
Cargo bar steel type 1840 1,900-2,800 mm	221840000012

Aluminum loading decking beam



Technical data

- > with steel end pieces which can be pulled out on both sides for fixing in a combi or anchor combi lashing track
- > end pieces equipped with innovative "Easy-Unlock button"
- > application range: 2,430 – 2,650 mm
- > blocking force: 1.100 daN
- > PL: 1.300 daN

Designation	Item number
Decking beam type 1835 2,430–2,650 mm for anchor combi lashing track	22183500-2320

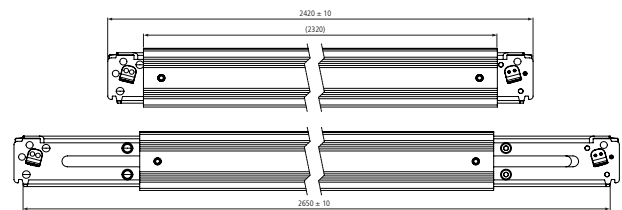
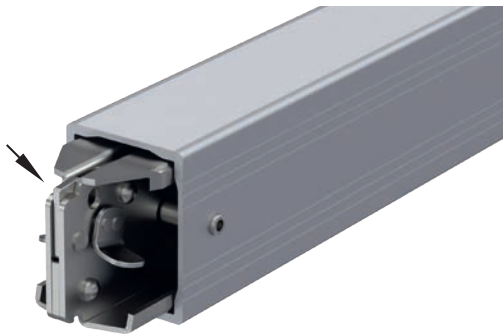

Locked state in the lashing track

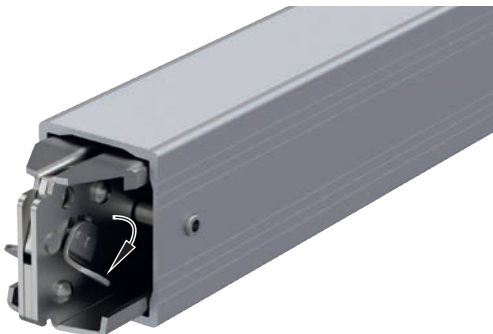

Simple unlocking by slightly pressing the "Easy-Unlock" button

Loading beam suitable for these tracks

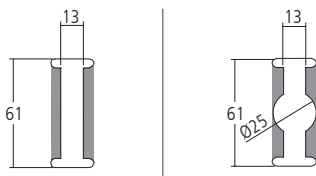

Aluminum loading decking beam



Technical data

- > with double-sided extendible steel end pieces for fixing in a Talfix perforated sheet panel
- > application range: 2,460 – 2,700 mm
- > blocking force: 1.100 daN
- > PL: 1.300 daN

Designation	Item number
Decking beam type 1839 2,460-2,700 mm for Talfix perforated plate panels	22183940-2350

Loading beam suitable for these perforated sheets

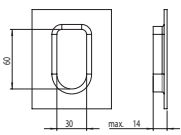

Unlocking bar for sliding decking beam

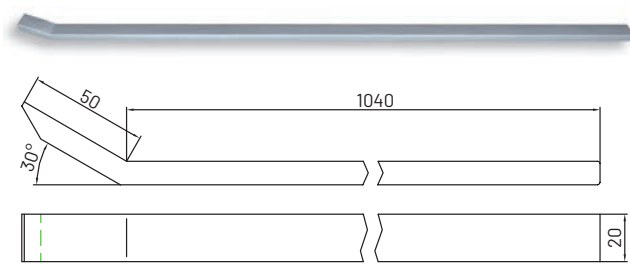

Designation	Item number
Unlocking bar for sliding decking beam	227000000020

Aluminum sliding decking beam 7007, 7008



Technical data

- > version 7007: with double-sided extendible aluminum end pieces for fixing in an aluminum guide rail (50 mm rail width)
- > version 7008: with double-sided extendible aluminum end pieces for fixing in an aluminum guide rail (68 mm rail width)
- > application range: 2,450 – 2,530 mm
- > blocking force: 1.100 daN
- > PL: 1.300 daN

Designation	Item number
Sliding decking beam type 7007 2,450-2,530 Standard (50 mm track width)	227007000020
Sliding decking beam type 7008 2,450-2,530 Schmitz (68 mm track width)	227008000020

Loading beam suitable for these tracks



Single aluminum guiding track 7002



Tandem aluminum guiding track 7002

Aluminum sliding decking beam 5003



Technical data

- > with double-sided extendible steel end pieces for fixing in a steel guiding track (50 mm rail width)
- > application range: 2,450 – 2,530 mm
- > blocking force: 1.100 daN
- > PL: 1.300 daN

Designation	Item number
Sliding decking beam type 5003 2,450-2,530 mm for KRONE swap boxes	225003000012

Loading beam suitable for these tracks



Single steel
guiding track
7004

Aluminum sliding decking beam 7105



Technical data

- > with double-sided extendible aluminum end pieces for locking in an airline rail made of aluminum
- > application range: 2,370 – 2,600 mm
- > blocking force: 1.100 daN
- > PL: 1.300 daN

Designation	Item number
Sliding decking beam type 7105 2,370-2,600 mm for airline track	227105000120

Loading beam suitable for airline guide lashing tracks

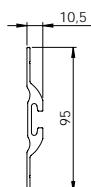

Single airline
lashing track
5001

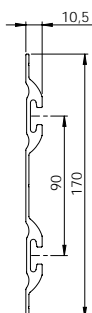

Tandem airline
lashing track
5021

Garment rail K7 with plastic end piece



Technical data

- > for fixing in a full or half-flanged keyhole plate
- > application range: 2,420 – 2,500 mm
- > support tube length: 2,370 mm (chrome-plated)
- > spring function: pulling
- > equipped with two Velcro straps for securing the throw bar
- > load capacity max. 400 kg

Designation	Item number
Garment rail type K7 2,420-2,500 mm for flanged keyhole plates	267191237017

Garment rail U71 with steel end piece



Technical data

- > for locking in a combi or anchor combi rail
- > application range: 2,420 – 2,500 mm
- > support tube length: 2,370 mm (chrome-plated)
- > without spring function
- > equipped with two Velcro straps for securing the throw bar
- > load capacity max. 400 kg

Designation	Item number
Garment rail type U71 2,420-2,500 mm for anchor combi lashing track	267382137017

Garment rail S7 with steel end piece



Technical data

- > for fixing in a keyhole lashing track without flanging
- > application range: 2,420 – 2,500 mm
- > support tube length: 2,370 mm (chrome-plated)
- > without spring function
- > equipped with two Velcro straps for securing the throw bar
- > load capacity max. 400 kg

Designation	Item number
Garment rail type S7 2,420-2,500 mm for keyhole lashing track	267390337017

Door gears

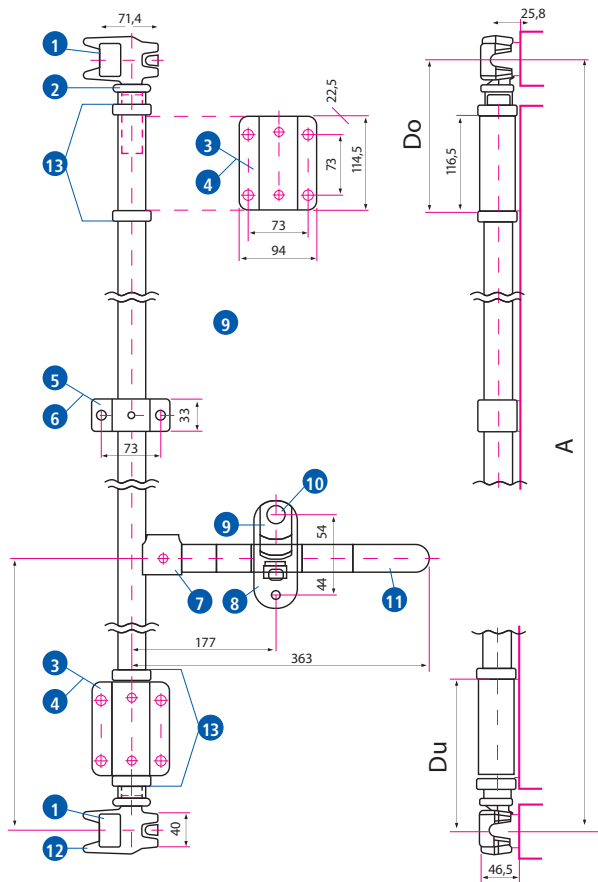

> bolt, hot-dip galvanized (9)

Designation	Item number
Bar, hot-dip galvanised	34012.05

> rivet, galvanized (10)

Designation	Item number
Rivet, galvanized	33089.03

> lever, hot-dip galvanized (11)

Designation	Item number
Lever, hot-dip galvanised	34090.05

> cam piece, untreated (12)

Designation	Item number
Cam piece, untreated	34201.01

> anti-rack ring, untreated (13)

Designation	Item number
Anti-rack ring, untreated	33901.01

Technical data

- > complete "Powerbrace 3491" kit
- > without tube

Designation	Item number
DOOR GEAR kit complete series 3491	3491000

> bracket, untreated (1)

Designation	Item number
Bracket, untreated	34237.01

> cam piece, untreated (2)

Designation	Item number
Cam piece, untreated	34202.01

> rod guide, hot-dip galvanized (3)

Designation	Item number
Rod guide, hot-dip galvanised	36008.05

> bushing for rod guide, plastic (4)

Designation	Item number
Socket for rod guide, plastic	36009.01

> rod bracket, hot-dip galvanized (5)

Designation	Item number
Rod bracket, hot-dip galvanised	36010.05

> bushing for rod bracket, plastic (6)

Designation	Item number
Socket for rod bracket, plastic	36011.01

> lever joint, untreated (7)

Designation	Item number
Lever joint, untreated	33071.01

> lever bracket, hot-dip galvanized (8)

Designation	Item number
Lever bracket, hot-dip galvanised	34011.05

Top seller

Airline lashing track 5503

More on page 68



**Cargo securing for
transporters and trailers**

Airline lashing tracks



The WISTRA airline lashing tracks and accessories are subject to constant material and quality checks.

With the continuously growing number of different designs, we offer our customers airline lashing tracks for the different areas in the transporter, trailer and luggage area.

An extensive offer of lashing straps, Safeguard cargo securing nets, locking and cargo bar systems, clothes transport rails as well as fastening systems and various end caps round off the range.

The WISTRA airline lashing program includes non-coated standard versions.

On request, we also offer special solutions and designs with holes or surface finishes such as powder or anodized coatings.

We deliberately do without impressive strength values. In our in-house test stand, the LC values for single and double fittings with the fastenings specified by us for the respective versions were determined.

Please note that the type of connection (screws, rivets, adhesives, etc.) and the strength of the substrate (spars, beams, sheets, etc.) are decisive when installing airline lashing tracks.

A further decisive factor is which lashing strap is used with which end fitting (single, double or quattro) and at which angle.

Our sales team will gladly assist you with your selection.

WISTRA Info

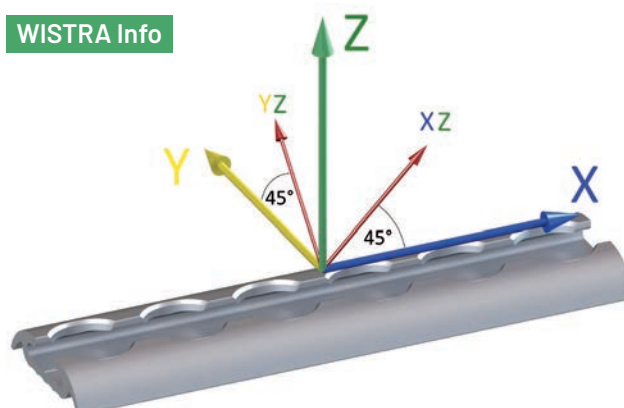

Custom made track

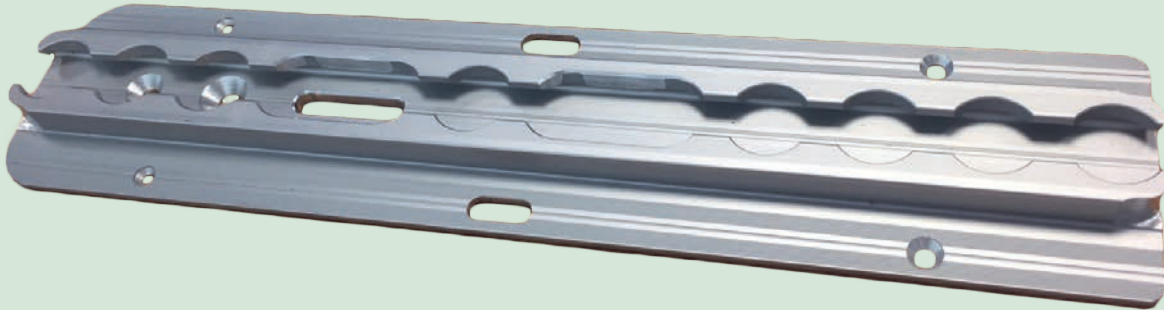

Configure your airline lashing track yourself!

- 1 You determine the type.
- 2 You choose the surface quality for aluminium tracks: untreated, anodised or powder-coated.
- 3 You determine the length.
- 4 You determine the number and design of the mounting hole.
- 5 You determine possible radii at the corners.

We implement your wishes. Contact us!

Airline lashing track 5503

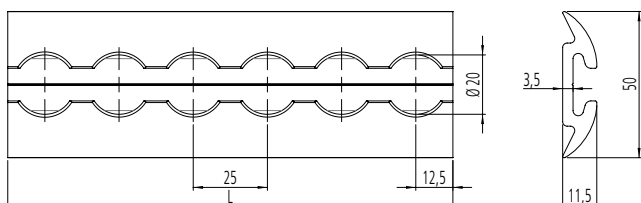
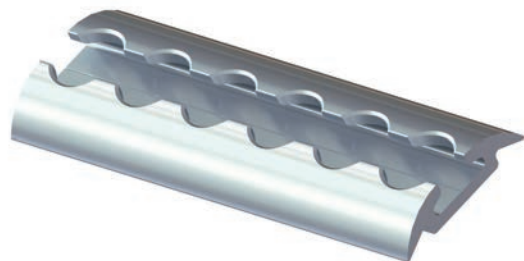

Technical data

- > semi-circular design
- > track width: 50 mm
- > hole diameter: 20 mm
- > hole pattern: 25 mm
- > length: 6,000 mm +5/-0 / 3,000 mm +1/-5 / 2,000 mm +1/-5
- > material: aluminum, untreated

Designation	Item number
Airline lashing track type 5503 6,000 mm aluminium, untreated	21550320-6000
Airline lashing track type 5503 3,000 mm aluminium, untreated	21550320-3000
Airline lashing track type 5503 2,000 mm aluminium, untreated	21550320-2000

LC strength

WIS end fitting	382	380
Z 90°	500 daN	1,000 daN
X-Z 45°	500 daN	1,000 daN
Y-Z 45°	400 daN	900 daN

LC strength for mounting: every 75 mm with a countersunk screw M6 DIN 7991 10.9

End cap in click version



Technical data

- > for airline track Type 5503
- > colour: black

Designation	Item number
End cap for airline track type 5503, click version	215106001540

Technical data

- > for airline track Type 5503
- > colour: grey

Designation	Item number
End cap for airline track type 5503, click version	215106501240

Airline lashing track 5513

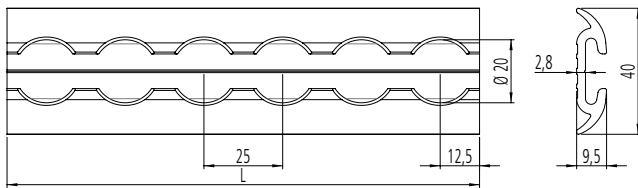

Technical data

- > semi-circular design
- > track width: 40 mm (slim version)
- > hole diameter: 20 mm
- > hole pattern: 25 mm
- > length: 3,000 mm +1/-5 / 2,000 mm +1/-5 / 1,000 mm +1/- 5
- > material: aluminum, untreated

Designation	Item number
Airline lashing track type 5513 3,000 mm aluminium, untreated slim	21551320-3000
Airline lashing track type 5513 2,000 mm aluminium, untreated slim	21551320-2000
Airline lashing track type 5513 1,000 mm aluminium, untreated slim	21551320-1000

LC strength

WIS end fitting	382	380
Z 90°	500 daN	600 daN
X-Z 45°	500 daN	500 daN
Y-Z 45°	350 daN	400 daN

LC-strength for mounting: every 75 mm with a countersunk screw M5 DIN 7991 10.9

End cap in click version



Technical data

- > for airline track Type 5513
- > colour: black

Designation	Item number
End cap for airline track type 5513, click version	215113001540

Airline lashing track 5504

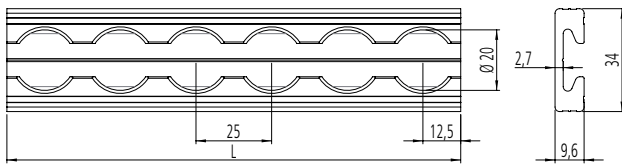

Technical data

- > angular design
- > track width: 34 mm
- > hole diameter: 20 mm
- > hole pattern: 25 mm
- > length: 6,000 mm +5/-0 / 3,000 mm +5/-0 / 2,000 mm +5/-0
- > material: aluminum, untreated

Designation	Item number
Airline lashing track type 5504 6,000 mm aluminium, untreated	21550420-6000
Airline lashing track type 5504 3,000 mm aluminium, untreated	21550420-3000
Airline lashing track type 5504 2,000 mm aluminium, untreated	21550420-2000

LC strength

WIS end fitting	382	380
Z 90°	500 daN	500 daN
X-Z 45°	500 daN	500 daN
Y-Z 45°	400 daN	400 daN

LC-strength for mounting: every 75 mm with a countersunk screw M5 DIN 7991 10.9

End cap in click version

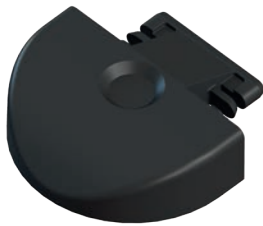

Technical data

- > for airline track Type 5504
- > colour: black

Designation	Item number
End cap for airline track type 5504, click version	215103001540

Airline lashing track 5524

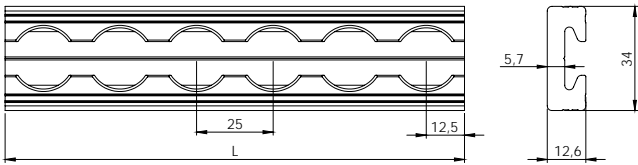

Technical data

- > angular design
- > track width: 34 mm
- > hole diameter: 20 mm
- > hole pattern: 25 mm
- > length: 6,000 mm +5/-0 / 3,000 mm +5/-0 / 2,000 mm +5/-0
- > material: aluminum, untreated

Designation	Item number
Airline lashing track type 5524 6,000 mm aluminium, untreated	21550420-6000
Airline lashing track type 5524 3,000 mm aluminium, untreated	21550420-3000

LC strength

WIS end fitting	382	380
Z 90°	500 daN	500 daN
X-Z 45°	500 daN	500 daN
Y-Z 45°	400 daN	400 daN

LC-strength for mounting: every 75 mm with a countersunk screw M5 DIN 7991 10.9



Airline lashing track 5514

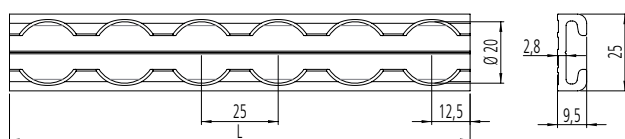

Technical data

- > angular design
- > track width: 25 mm (slim version)
- > hole diameter: 20 mm
- > hole pattern: 25 mm
- > length: 3,000 mm +1/-5 / 2,000 mm +1/-5 / 1,000 mm +1/-5
- > material: aluminum, untreated

Designation	Item number
Airline lashing track type 5514 3,000 mm aluminium, untreated slim	21551420-3000
Airline lashing track type 5514 2,000 mm aluminium, untreated slim	21551420-2000
Airline lashing track type 5514 1,000 mm aluminium, untreated slim	21551420-1000

LC strength

WIS end fitting	382	380
Z 90°	450 daN	450 daN
X-Z 45°	350 daN	450 daN
Y-Z 45°	250 daN	300 daN

LC-strength for mounting: every 75 mm with a countersunk screw M5 DIN 7991 10.9

End cap in click version



Technical data

- > for airline track Type 5514
- > colour: black

Designation	Item number
End cap for airline track type 5514, click version	215114001540

Airline lashing track 5508, pre-assembled



blue colour based on RAL 5002

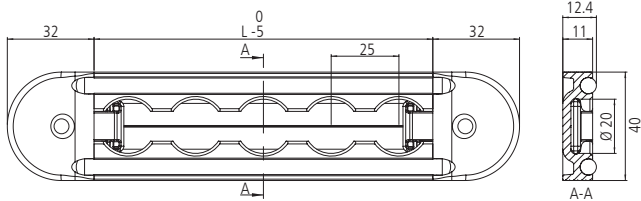

Technical data

- > track width: 40 mm
- > hole diameter: 20 mm
- > hole pattern: 25 mm
- > length of lashing track: 3,000 mm +1/-5 / 2,000 mm +1/-5 / 1,000 mm +1/-5
- > length incl. end caps: 3,064 mm +1/-5 / 2,064 mm +1/-5 / 1,064 mm +1/-5
- > material: aluminum, untreated

angular design black with integrated rubber protection and 2 end caps

Designation	Item number
Airline lashing track type 5508 set 3,000 mm black rubber protection	21550877-3000
Airline lashing track type 5508 set 2,000 mm black rubber protection	21550877-2000
Airline lashing track type 5508 set 1,000 mm black rubber protection	21550877-1000

angular design blue with integrated silicone protection and 2 end caps

Bezeichnung	Artikelnummer
Airline lashing track type 5508 set 3,000 mm blue silicone protection	21550878-3000
Airline lashing track type 5508 Set 2,000 mm blue silicone protection	21550878-2000
Airline lashing track type 5508 Set 1,000 mm blue silicone protection	21550878-1000

Airline lashing track 5508

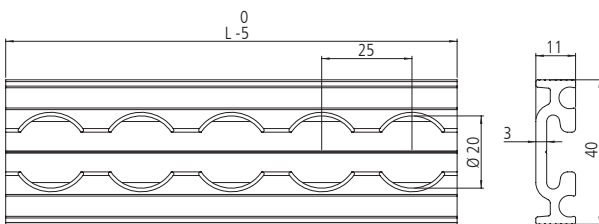
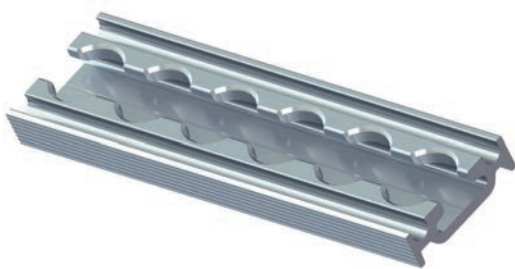

Technical data

- > design without rubber protection and without end caps
- > track width: 40 mm
- > hole diameter: 20 mm
- > hole pattern: 25 mm
- > length of lashing track: 3,000 mm +1/-5
- > material: aluminum, untreated

Designation	Item number
Airline lashing track type 5508 3000 mm aluminium, untreated without protection	21550820-3000

LC strength

WIS end fitting	382	380
Z 90°	500 daN	1,000 daN
X-Z 45°	500 daN	1,000 daN
Y-Z 45°	400 daN	900 daN

LC strength for mounting: every 75 mm with a countersunk screw M6 DIN 7991 10.9

Band for airline track Type 5508



blue colour based on RAL 5002

Technical data

- > rubber band black: 50 metres on a roll

Designation	Item number
Airline lashing track type 5508 rubber metre goods (50 m rolls) in black	21550800-50000

- > silicone band blue: 50 metres on a roll

Designation	Item number
Airline lashing track type 5508 silicone metre goods (100 m rolls) in blue	21550801-100000

End cap in click version



blue colour based on RAL 5002

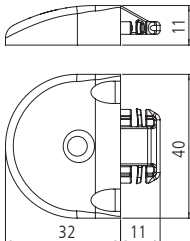

Technical data

- > for airline track Type 5508

Black plastic end cap

Designation	Item number
End cap for airline track type 5508, click version black	215104001540

Blue plastic end cap

Designation	Item number
End cap for airline track type 5508, click version blue	215104001340

Airline lashing track 5507

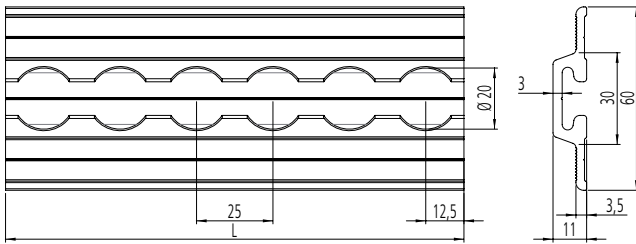
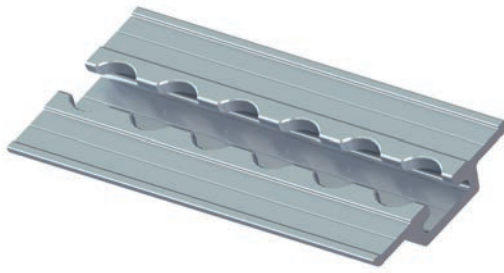

Technical data

- > with top wing for integration in the cargo area floor
- > track width: 60 mm
- > hole diameter: 20 mm
- > hole pattern: 25 mm
- > length: 3,000 mm +1/-5
- > material: aluminum, untreated

Designation	Item number
Airline lashing track type 5507 3,000 mm aluminium, untreated	21550720-3000

LC strength

WIS end fitting	382	380
Z 90°	500 daN	1,000 daN
X-Z 45°	500 daN	1,000 daN
Y-Z 45°	400 daN	900 daN

LC strength for mounting: every 75 mm with a countersunk screw M6 DIN 7991 10.9

Airline lashing track 5501

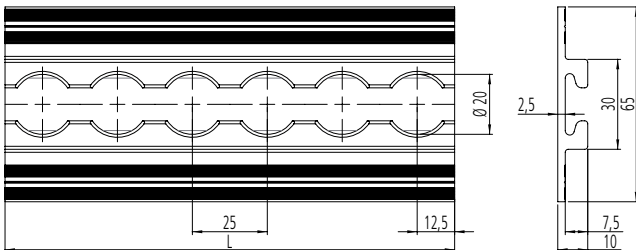
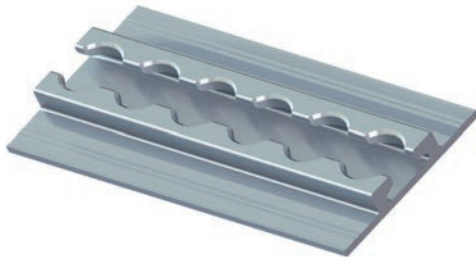

Technical data

- > with bottom wing for integration in the cargo area floor
- > track width: 65 mm
- > track height: 10 mm
- > hole diameter: 20 mm
- > hole pattern: 25 mm
- > length: 3,000 mm +1/-5
- > material: aluminum, untreated

Designation	Item number
Airline lashing track type 5501 3,000 mm aluminium, untreated 10 mm	21550120-3000

LC strength

WIS end fitting	382	380
Z 90°	500 daN	500 daN
X-Z 45°	500 daN	500 daN
Y-Z 45°	400 daN	400 daN

Lashing capacity for attachment: every 75 mm oppositely with a countersunk screw M6 DIN 7380 8.8

Airline lashing track 5510

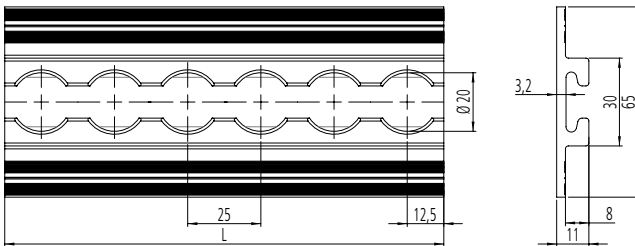
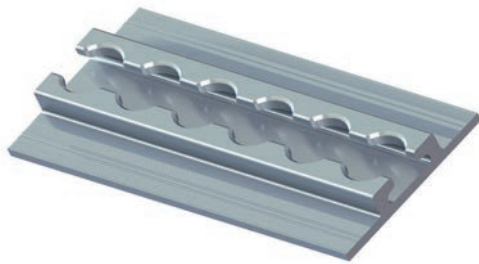

Technical data

- > with bottom wing for integration in the cargo area floor
- > track width: 65 mm
- > track height: 11 mm
- > hole diameter: 20 mm
- > hole pattern: 25 mm
- > length: 3,000 mm +1/-5
- > material: aluminum, untreated

Designation	Item number
Airline lashing track type 5510 3,000 mm aluminium, untreated 11 mm	21551020-3000

LC strength

WIS end fitting	382	380
Z 90°	500 daN	1,000 daN
X-Z 45°	500 daN	1,000 daN
Y-Z 45°	400 daN	900 daN

Lashing capacity for attachment: every 75 mm oppositely with a countersunk screw M6 DIN 7380 8.8

Airline lashing track 5506

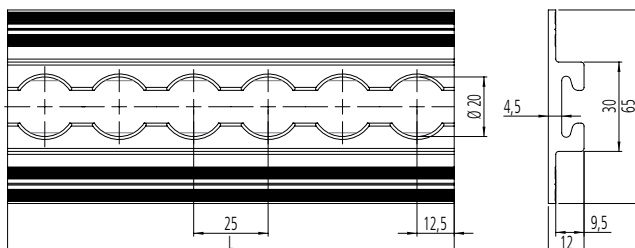

Technical data

- > with bottom wing for integration in the cargo area floor
- > track width: 65 mm
- > track height: 12 mm
- > hole diameter: 20 mm
- > hole pattern: 25 mm
- > length: 6,000 mm +1/-5 / 3,000 mm +1/-5
- > material: aluminum, untreated

Designation	Item number
Airline lashing track type 5506 6,000 mm aluminium, untreated 12 mm	21550620-6000
Airline lashing track type 5506 3,000 mm aluminium, untreated 12 mm	21550620-3000

LC strength

WIS end fitting	382	380
Z 90°	500 daN	1,000 daN
X-Z 45°	500 daN	1,000 daN
Y-Z 45°	400 daN	900 daN

Lashing capacity for attachment: every 75 mm oppositely with a countersunk screw M6 DIN 7380 8.8

End cap in click version



Technical data

- > for airline track Type 5506
- > colour: black

Designation	Item number
End cap for airline track type 5506, click version	215105001540

Airline lashing track 5502

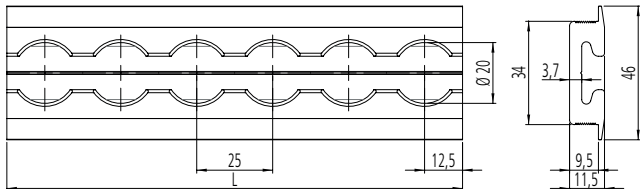
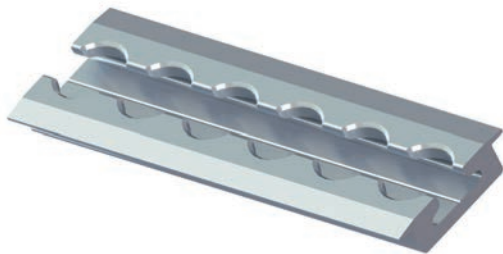

Technical data

- > with top wing for integration in the cargo area floor
- > track width: 46 mm
- > hole diameter: 20 mm
- > hole pattern: 25 mm
- > length: 6,000 mm +1/-5 / 3,000 mm +1/-5 / 2,000 mm +1/-5
- > material: aluminum, untreated

Designation	Item number
Airline lashing track type 5502 6,000 mm aluminium, untreated	21550220-6000
Airline lashing track type 5502 3,000 mm aluminium, untreated	21550220-3000
Airline lashing track type 5502 2,000 mm aluminium, untreated	21550220-2000

LC strength

WIS end fitting	382	380
Z 90°	500 daN	1,000 daN
X-Z 45°	500 daN	1,000 daN
Y-Z 45°	400 daN	900 daN

LC strength for mounting: every 75 mm with a countersunk screw M6 DIN 7991 10.9

End cap in click version

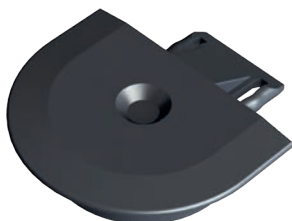

Technical data

- > for airline track Type 5502
- > colour: black

Designation	Item number
End cap for airline track type 5502, click version	215102001540

Rail with lashing rods 4710

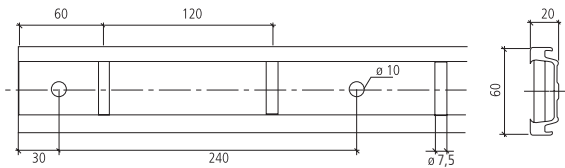

Technical data

- > with rubber protection
- > rail width: 66 mm (incl. protective profile)
- > rail height: 23 mm (incl. protective profile)
- > rod diameter: 8 mm
- > hole pitch: $\varnothing 10$ mm, grid: 240 mm
- > pin: $\varnothing 7.5$ mm, grid: 120 mm
- > aluminum, untreated

Designation	Item number
Track with pins type 4710 6,000 mm with rubber protection	21471020-6000
Track with pins type 4710 3,000 mm with rubber protection	21471020-3000
Track with pins type 4710 2,000 mm with rubber protection	21471020-2000

End cap



Technical data

- > for 4710 rail with lashing rods
- > color: black

Designation	Item number
End cap for track with pins type 4710 in black	212106661540

Anchor combination lashing rail 3009

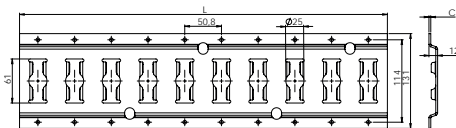
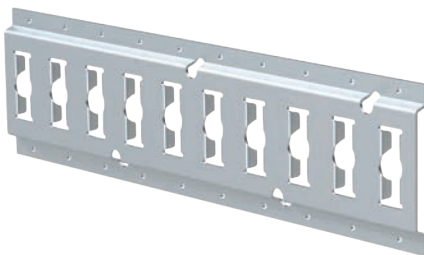

Technical data

- > with drain hole
- > rail width: 131 mm
- > rail height: 12 mm
- > hole pitch: 50.8 mm

Designation	Item number
Anchor combi lashing track type 3009 3.0 mm alum. 3,048 mm	213009300020

End cap

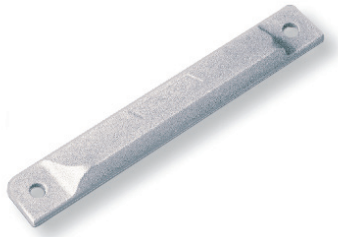

Technical data

- > for anchor combination lashing rail type 3009
- > color: grey

Designation	Item number
Protective wedge for combi / anchor combi lashing track	212109951240

Airline lashing rail cover

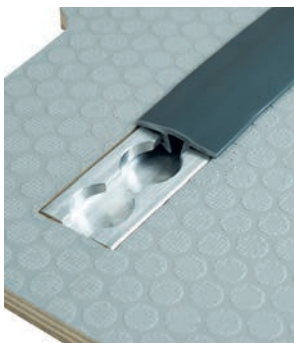

grey colour based on RAL 7011

Technical data

- > cover for airline rails
- > standard length: 3,000 mm
- > weight: 665 g
- > material: plastic
- > color: grey

Designation	Item number
Cover profile grey for airline tracks 3,000 mm	21510901-3000

Cover plug for the airline track

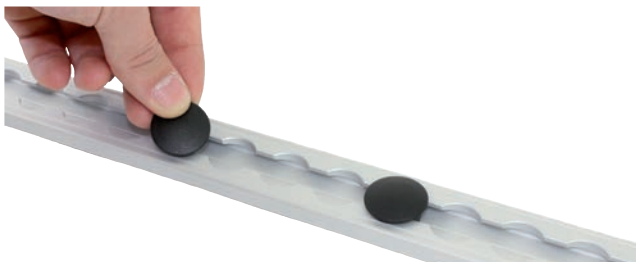

Technical data

- > material: plastic
- > prevents direct contact between cargo and lashing track

Designation	Item number
Cover plug plastic for airline track	21510100

LED airline lashing track 5523



Electrical connection

The connection is made by a 2-core cable with 2 x 0.5 mm² cross-section.

If required, the caps can also be screwed on. For this purpose, the caps are drilled from the back with a 4.3 mm drill bit.

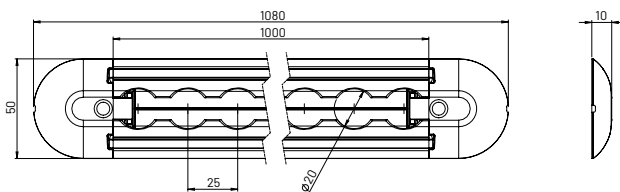

Technical data

- > semi-circular version with 2 integrated LED strips and 2 end caps
- > track width: 50 mm
- > track height: 10 mm
- > hole diameter: 20 mm
- > hole pattern: 25 mm
- > length of lashing track: 1,000 mm +1/-5
- > length incl. end caps: 1,080 mm +1/-5
- > material: aluminum, untreated
- > nominal voltage: 12 V
- > nominal power: 13.8 W (total power 27.6 W)
- > colour temperature: 6,500 K
- > lumen: 870 lm per strip
- > protection class: IP67
- > weight: 565 g

Designation	Item number
LED airline lashing track 1,000 mm bare LED set of 1 (connection cable 1.0 m)	215523770100
LED airline lashing track 1,000 mm bare LED set of 5 (connection cable 1.0 m)	215523770500
LED airline lashing track 1,200 mm bare LED set of 1 (connection cable 1.0 m)	NEW! 215523770100-2

LC strength

WIS end fitting	382	380
Z 90°	500 daN	600 daN
X-Z 45°	500 daN	500 daN
Y-Z 45°	350 daN	400 daN

LC-strength for mounting: every 75 mm with a countersunk screw M5 DIN 7991 10.9

End cap without connection terminal (click version)



Technical data

- > for airline track Type 5523
- > colour: black

Designation	Item number
End cap for airline track type 5523 click version without connection clamp	215123011540

End cap with connection terminal (click version)



Technical data

- > for airline track Type 5523
- > colour: black

Designation	Item number
End cap for airline track type 5523 click version with connection clamp	215123501540

LED strip



Technical data

- > length: 1,025 mm +/- 5
- > incl. 45 mm connection cable
- > incl. double-sided adhesive tape on the back side
- > nominal voltage: 12 V
- > nominal power: 13.8 W
- > colour temperature: 6,500 K
- > lumen: 870 lm per strip
- > protection class: IP67

Designation	Item number
LED stripe for airline track type 5523	21552300-1000

Angle airline track



Technical data

- > shape (track): round / half-round
- > length: 1000 mm +/- 5 mm
- > hole diameter: 20 mm (airline)
- > hole pattern: 25 mm
- > material: bright aluminum
- > length of angle plate: 1100 mm
- > length of airline track 1000 mm +/- 5mm, including end caps 1050 mm +/- 5mm
- > every 150 mm holes for fastening the angle plate

Designation	Item number
Angle airline track	160000000203

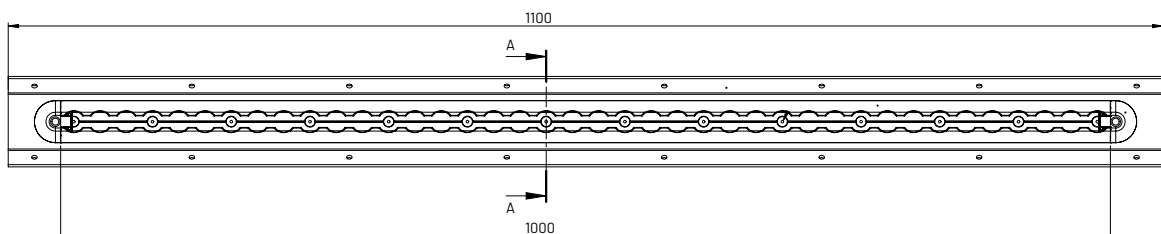

Lashing point 315

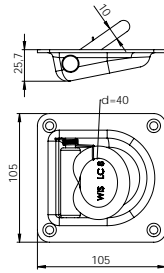

Technical data

- > LC (lashing capacity): 800 daN
- > material: steel, galvanized
- > size: 105 x 105 mm

Designation	Item number
Lashing point 315 LC 800 daN	243150000012

Lashing point 370

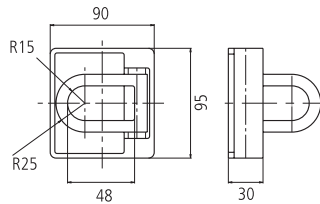

Technical data

- > LC (lashing capacity): 2,500 daN
- > material: steel, untreated
- > size: 95 x 90 x 30 mm

Designation	Item number
Lashing point 370 LC 2,500 daN	243700000010

Lashing point 360

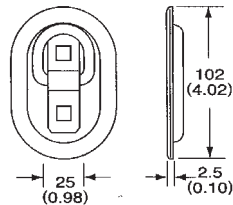

Technical data

- > LC (lashing capacity): 350 daN
- > material: steel, galvanized
- > size: 104 x 70 mm (oval shape)

Designation	Item number
Lashing point 360 LC 350 daN	243600000012

Lashing point 362

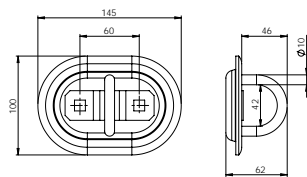

Technical data

- > LC (lashing capacity): 800 daN
- > material: steel, galvanized
- > size: 145 x 100 mm (oval shape)

Designation	Item number
Lashing point 362 LC 800 daN	243620000012

Screw-in fitting



Technical data

- > thread: M8
- > LC (lashing capacity): 500 daN
- > incl. drive-in nut

Designation	Item number
Screw-in fitting M8 incl. drive-in nut	140000037701

U-Clamps

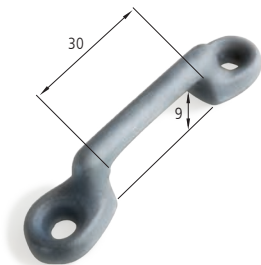

Technical data

- > suitable for attaching 25 mm straps
- > material: steel, galvanized
- > overall length: 68 mm
- > overall width: 15 mm
- > overall height: 15 mm
- > hole spacing: 52 mm
- > mounting holes for 5 mm rivets
- > weight: ca. 22 g

Designation	Item number
U-Clamp	950300001812



Suitable for use with the WTR 1000 ratchet lashing strap
WTR 1000 ratchet lashing strap

- > strap: 25 mm, blue

Designation	Item number
Ratchet lashing strap WTR 1000 with flat hook 025 SE 0.3 + LE 3.2 signal blue with securing seam	1251293

Single airline fitting 382



Technical data

- > LC (lashing capacity): 500 daN
- > housing made of plastic
- > colour of plastic: blue

Designation	Item number
Single airline fitting type 382 in blue	140000038200

Single airline fitting 385



Technical data

- > LC (lashing capacity): 500 daN
- > housing made of plastic
- > colour of plastic: red

Designation	Item number
Single airline fitting type 385 in red	140000038500

Single airline fitting 386



Technical data

- > LC (lashing capacity): 500 daN
- > housing made of plastic
- > colour of plastic: black

Designation	Item number
Single airline fitting type 386 in black	140000038600

Single airline fitting 387



Technical data

- > LC (lashing capacity): 500 daN
- > housing made of plastic
- > spring, ring and holding pin made of stainless steel
- > colour of plastic: anthracite

Designation	Item number
Single airline fitting type 387 in anthracite STAINLESS STEEL	140000038700

Single airline fitting 388



Technical data

- > LC (lashing capacity): 500 daN
- > housing made of plastic
- > colour of plastic: orange

Designation	Item number
Single airline fitting type 388 in orange	140000038800

Single airline fitting 379



Technical data

- > LC (lashing capacity): 500 daN
- > ring diameter (inner): 34 mm
- > material: steel, aluminum

Designation	Item number
Single airline fitting type 379 steel/alum.	140000037900

Double airline fitting 380



Technical data

- > LC (lashing capacity): 10 kN
- > material: steel, galvanized

Designation	Item number
Double-airline end fitting type 380 without ring	140000038100

Double airline fitting 381



Technical data

- > LC (lashing capacity): 10 kN
- > ring diameter (inner): 32 mm
- > material: steel, galvanized

Designation	Item number
Double-airline end fitting type 381 with ring	140000038110

Quattro airline fitting 383



Technical data

- > LC (lashing capacity): 25 kN
- > material: steel, galvanized

Designation	Item number
Quattro airline fitting type 383	140000038300

Airline lashing point



Technical data

- > including 2 mounting holes
- > mounting holes: M5 countersunk head
- > diameter: 45 mm
- > material: aluminum, untreated

Designation	Item number
Airline lashing point round 45 mm - 2 x M5 counter-sunk head	21560125

Rectangular airline lashing point

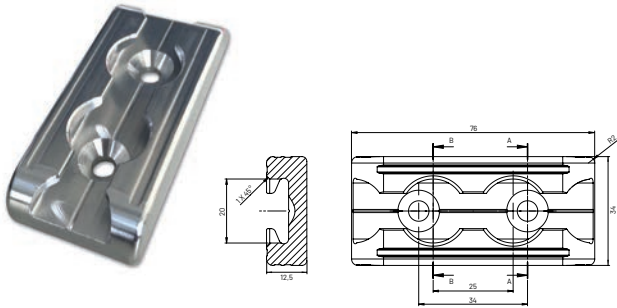

Technical data

- > L x W x H 76 mm x 34 mm x 12.5 mm
- > Including 2 mounting holes M6 countersunk head
- > material: aluminum, untreated
- > load capacity: 400 daN
- > weight: approx. 60 g

Designation	Item number
Airline lashing point rectangular 76 x 34 mm - 2 x M6 countersunk head	2430003

Wire hooks for airline fitting



Technical data

- > with PVC coating for hanging up cables or clothing
- > carrying capacity: 50 kg
- > fitting not included

Designation	Item number
Wire hook type 527 for single airline fitting	140000052700

Slot nut with threaded holes 2 x M6 and 1 x M8



Technical data

- > for fixing different materials to airline lashing tracks
- > material: steel, galvanized
- > size: 50 x 18 mm
- > distance between threaded holes: 25 mm

Designation	Item number
Slot nut with 2 x M6 and 1 x M8	215108200612

Slot nut with three threaded holes M6



Technical data

- > for fixing different materials to airline lashing tracks
- > material: steel, galvanized
- > size: 75 x 18 mm
- > distance between threaded holes: 25 mm

Designation	Item number
Slot nut with three threaded holes M6	215108300612

Sliding block with threaded bolt M8 and M10

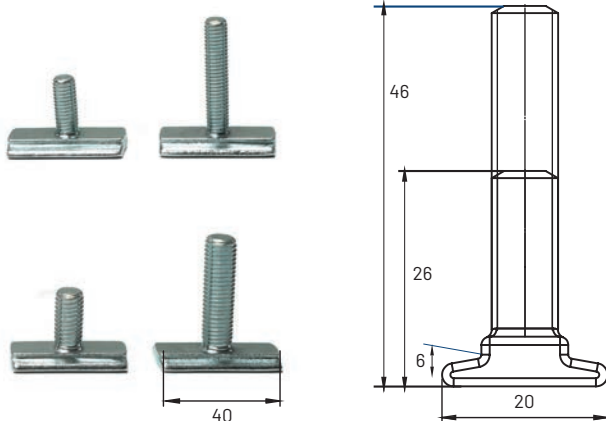

Technische Daten

- > for fixing various products to airline lashing tracks
- > threaded bolt M8/M10
- > material: steel, galvanized
- > LC (lashing capacity): 2.000 daN

Designation	Item number
Sliding block M8 with threaded bolt 20 mm	21510830
Sliding block M8 with threaded bolt 40 mm	21510831
Sliding block M10 with threaded bolt 20 mm	21510832
Sliding block M10 with threaded bolt 40 mm	21510833

Screw fitting with self-locking nut for airline lashing tracks



Technical data

- > thread: M8 x 25 / 30 / 40 / 60
- > material: steel, galvanized
- > pre-assembled

Designation	Item number
Screw fitting 5107 M8 x 25 with nut and shim	21510784
Screw fitting 5107 M8 x 30 with nut and shim	21510785
Screw fitting 5107 M8 x 40 with nut and shim	21510786
Screw fitting 5107 M8 x 60 with nut and shim	21510787

Screw-through fitting with plastic star grip for airline lashing tracks



Technical data

- > thread: M8 x 25 / 30 / 40 / 60
- > material: steel, galvanized
- > pre-assembled

Designation	Item number
Screw fitting 5108 M8 x 25 with plastic star grip	21510864
Screw fitting 5108 M8 x 30 with plastic star grip	21510865
Screw fitting 5108 M8 x 40 with plastic star grip	21510866
Screw fitting 5108 M8 x 60 with plastic star grip	21510867

Shovel holder with rubber band



Technical data

- > length of the rubber band: 60 mm / 80 mm

Designation	Item number
Shovel holder with elastic band 60 mm	392003
Shovel holder with elastic band 80 mm	392004

WISTRA AirlineStop

NEW!
AirlineStop for safe transport



Scan QR code and watch video

[You can find the video here.](#)

The airline track must be mounted flush with the vehicle floor and not deeper.

Against pallet slipping on the loading space

With this AirlineStop, pallets can be secured against slipping on the loading space. The fitting can be used directly as a blockage in combination with integrated airline rails in the vehicle floor.

Suitable holding profiles between two fittings are **50 x 50 mm aluminum profiles**, WISTRA article numbers: **221851-1975** and **221851-1000**.

It is also possible to use a locking bar with a 19 mm pin at the ends. Due to the symmetrical design of the article, there are no different fittings for the left or right side.

In illustration B you can see the application of the article tilted by 90 degrees. For this application we recommend securing the connection with a pin / split of the aluminum profile.

Technical data

- > for profiles up to 50 mm thickness
- > BC (breaking capacity) 400 daN
- > material: steel, galvanized
- > size: 85 mm x 50 mm x 56,5 mm
- > weight: 410 g
- > height above the vehicle floor: 49 mm
- > center hole: \varnothing 20 mm for \varnothing 19 mm spigots
- > 4 x 6 mm hole for dowel pins

Also available as a set:

- Set 1: 2x AirlineStop, 1x aluminum profile (length 1.000 mm)
- Set 2: 2x AirlineStop, 1x aluminum profile (length 1.975 mm)

Designation	Item number
AirlineStop for airline track	140000040000
Profile alum. 50 x 50 1,000 mm for pallet stop	221851-1000
Profil alum. 50 x 50 1,975 mm for pallet stop	221851-1975
Airline Stop pallet stop set 1,000 mm	221104001000
Airline Stop pallet stop set 1,975 mm	221104001975

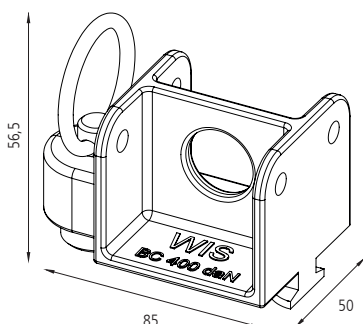

A: AirlineStop with a barrier bar



B: Lateral application

WTR 1000 Ratchet lashing strap



Technical data

- > two-part - SE 0.5 m + LE 4.5 m
- > according to EN 12195-2
- > LC 500 daN with straight tension
- > STF 200 daN
- > strap: 25 mm, red

with end fitting **002** (claw hook)

Designation	Item number
Ratchet lashing strap WTR 1000 claw hook 002 SE 0.5 + LE 4.5 red	1255107



with end fitting **025** (flat hook with safety mechanism)

Designation	Item number
Ratchet lashing strap WTR 1000 flat hook 025 SE 0.5 + LE 4.5 red	1255216



with end fitting **379** (single airline fitting)

Designation	Item number
Ratchet lashing strap WTR 1000 airline fitting 379 SE 0.5 + LE 4.5 red	11909023790545

WTR 1000 Ratchet lashing strap



Technical data

- > two-part – SE 0.2 m + LE 0.73 m / SE 0.2 m + LE 3.2 m
- > according to EN 12195-2
- > LC 500 daN with straight tension
- > STF 200 daN
- > strap: 25 mm, signal blue
- > The long end is connected to the short end by a safety seam.

with end fitting **382** (single airline fitting)

Designation	Item number
Ratchet lashing strap WTR 1000 airline fitting 379 SE 0.2 + LE 0.73 blue with securing seam	1251286



with end fitting **201** (flat hook)

Designation	Item number
Ratchet lashing strap WTR 1000 flat hook 201 SE 0.2 + LE 0.8 blue with securing seam	1250678



with end fitting **025** (flat hook with safety mechanism)

Designation	Item number
Ratchet lashing strap WTR 1000 flat hook 025 SE 0.3 + LE 3.2 blue with securing seam	1251293

WTR 800 Ratchet lashing strap



Technical data

- > two-part - SE 0.5 m + LE 4.5 m
- > according to EN 12195-2
- > LC 400 daN with straight tension
- > STF 200 daN
- > strap: 25 mm, grey, yellow

with end fitting **202** (stainless steel snap hook)

Designation	Item number
Ratchet lashing strap WTR 800 snap hook stainless steel 201 SE 0.5 + LE 4.5 grey	1250990



with end fitting **202** (snap hook)

Bezeichnung	Artikelnummer
Ratchet lashing strap WTR 800 snap hook stainless steel 201 SE 0.2 + LE 1.8 blue	1250812



with end fitting **002** (claw hook)

Designation	Item number
Ratchet lashing strap WTR 800 claw hook 002 SE 0.5 + LE 4.5 yellow	1257988

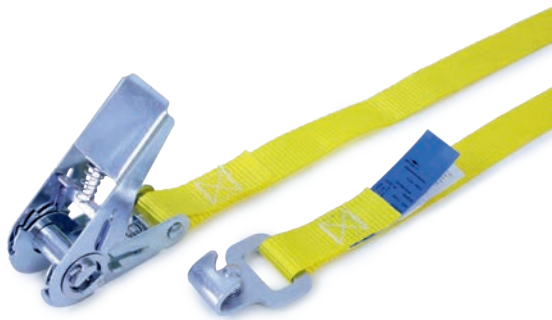

with end fitting **025** (flat hook with safety mechanism)

Designation	Item number
Ratchet lashing strap WTR 800 flat hook 025 SE 0.5 + LE 4.5 yellow	11906030250545



with end fitting **379** (single airline fitting)

Designation	Item number
Ratchet lashing strap WTR 800 airline fitting 379 SE 0.5 + LE 4.5 yellow	1258794



with end fitting **381** (double airline fitting)

Designation	Item number
Ratchet lashing strap WTR 800 double airline fitting 381 SE 0.5 + LE 4.5 yellow	1258052

WTR 800 Pressure ratchet lashing strap

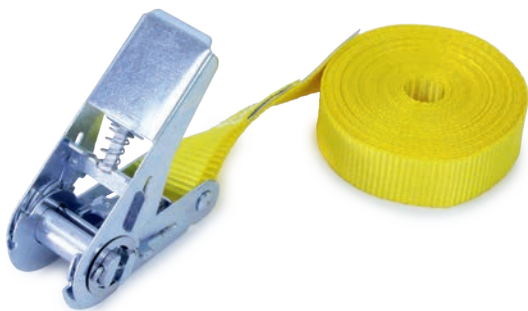

Technical data

- > single-part – 3.0 m / 5.0 m
- > according to EN 12195-2
- > lashing capacity LC 800 daN in strapping
- > strap: 25 mm, yellow

Designation	Item number
Ratchet lashing strap WTR 800 single-part 3.0 yellow	1259473
Ratchet lashing strap WTR 800 single-part 5.0 yellow	1259475

WTR 1500-826 Ratchet lashing strap



Technische Daten

- > two-part - FE 0,5
- > according to EN 12195-2
- > LC 750 daN with straight tension
- > STF 210 daN
- > with end fitting **826** (for Combi and Anchor Combi lashing rails)
- > strap: 50 mm, green

Bezeichnung	Artikelnummer
Ratchet lashing strap WTR 1500 fitting 826 for anchor tracks SE 0.2 + LE 0.8 green with securing seam	1500533
Ratchet lashing strap WTR 1500 fitting 826 for anchor tracks SE 0.2 + LE 1.8 green	1504226
Ratchet lashing strap WTR 1500 fitting 826 for anchor tracks SE 0.5 + 2.5 green	1504250
Ratchet lashing strap WTR 1500 fitting 826 for anchor tracks SE 0.5 + LE 4.5 green	1504252

* SN = securing seam (fixed and loose ends can not be separated) – e.g. for gas bottle holder

WTK 350 cam buckle strap



Technical data

- > single-part – 3.0 m / 5.0 m
- > according to EN 12195-2
- > LC 350 daN in strapping
- > strap: 25 mm, yellow

Designation	Item number
Cam buckle strap WTK 350 single-part 3.0 yellow	1253673
Cam buckle strap WTK 350 single-part 5.0 yellow	1253675

WTW 250 Automatic ratchet lashing strap



Technical data

- > two-part – SE 0.2 m + LE 2.0 m
- > based on EN 12195-2
- > LC 125 daN with straight tension
- > STF 27 daN
- > strap: 25 mm, black

with end fitting **002** (claw hook)

Designation	Item number
Automatic ratchet lashing strap 250 claw hook 002 SE 0.2 + LE 2.0 black automatic ratchet lashing strap	1250337

with end fitting **025** (flat hook with safety mechanism)



Designation	Item number
Automatic ratchet lashing strap 250 flat hook 025 SE 0.2 + LE 2.0 black automatic ratchet lashing strap	1250293

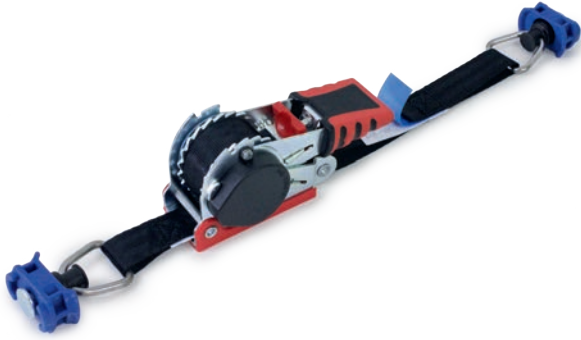

with end fitting **382** (single airline fitting)

Designation	Item number
Automatic ratchet lashing strap 250 airline fitting 379 SE 0.2 + LE 2.0 black automatic ratchet lashing strap	1250346



with end fitting **725** (S-hook with PVC cover)

Designation	Item number
Automatic ratchet lashing strap 250 S-hook 725 SE 0.2 + LE 2.0 black automatic ratchet lashing strap	1250150

WISTRA Safeguard cargo securing nets



For more than 20 years, WISTRA GmbH has also been offering cargo securing nets in its product range.

We offer a wide range of applications – even beyond the realms of cargo securing. The common lashing strap widths 25 mm, 35 mm and 50 mm and the different mesh apertures in combination with connection adapters for the vehicle or trailer, offer a variety of options.

We could implement more than 300 different versions for our customers up to now. The Safeguard cargo securing nets are planned and manufactured according to customer requirements.

Besides many individual products, customer-specific solutions have proven invaluable and have been manufactured more than 10,000 times.

Key application areas include:

- > rear cargo securing in closed bodies, the various swap bodies, containers and special containers
- > lateral cargo securing, e.g. for curtainsiders
- > cargo securing over the cargo on the floor and to the sides
- > retention nets for short timber transports
- > restraining nets for transporters
- > tie-down lashing cargo securing nets

Production, marking and testing are carried out in accordance with VDI Guideline 2700 Sheet 3.3 (and in accordance with DIN EN 12195-2).



Cargo securing for transporters and trailers



This results in a multitude of design possibilities, which are to be determined on the basis of years of experience at WISTRA and on the basis of the customer's requirements specification.

The following key data must be taken into account:

- use, handling and load data
- mesh size and fabric insert
- quantity and kind of tensioning and connecting elements
- use of linkages
- use of additional anti-theft devices

Safeguard load securing nets are manufactured for renowned customers like Deutsche Post, GLS, Hermes and many others, and have proven their practical worth across Europe.

In this catalogue, you will find a selection of net options. Please contact us if these do not meet your requirements. The WISTRA team is at your disposal with its many years of experience and also produces nets individually in quantities from 1 piece.



"QuickKEP" cargo securing net



Technical data

- > vertical transporter cargo securing net
- > strap width: 25 mm
- > strap colour: red
- > with alum. linkage on both sides for securing in wheelhouse area
- > 2 mounting levels for hanging up
- > LC net mounting point 250 daN
- > LC net total 600 daN
- > mesh check, production and marking according to VDI guideline 2700 Part 3.3
- > net height approx. 1,700 mm
- > weight net: approx. 6.8 kg
- > weight fitting 380 total: approx. 1.8 kg
- > bottom hook extended for simple insertion
- > spanner in label protector for adjusting the height for optimised fastening
- > available for MB Sprinter, VW Crafter, Renault Trafic, Ford Transit, Hyundai H50, Opel Movano, Iveco Daily, MAN TGE, Fiat Ducato, Peugeot Boxer, Citroën Jumper

Side mounting

- > WIS hook-in device for double airline fitting 380
- > 16 double airline fittings are already included in the set



"QuickKEP 2.0" cargo securing net



Technical data

- > vertical transporter cargo securing net
- > strap width: 25 mm
- > strap colour: red
- > with straight alum. linkage on both sides for universal use in H2 chassis
- > 2 mounting levels for hanging up
- > LC net mounting point 250 daN
- > LC net total 600 daN
- > mesh check, production and marking according to VDI guideline 2700 Part 3.3
- > net height: 1,668 mm
- > weight net: approx. 6.8 kg
- > weight fitting 380 total: approx. 1.8 kg
- > bottom hook extended for simple insertion
- > spanner in label protector for adjusting the height for optimised fastening
- > four quick-release fasteners

Side mounting

- > WIS hook-in device for double airline fitting 380
- > 16 double airline fittings are already included in the set

Packaged as set for universal use

Designation	Item number
Safeguard cargo securing net QuickKEP	273480002230

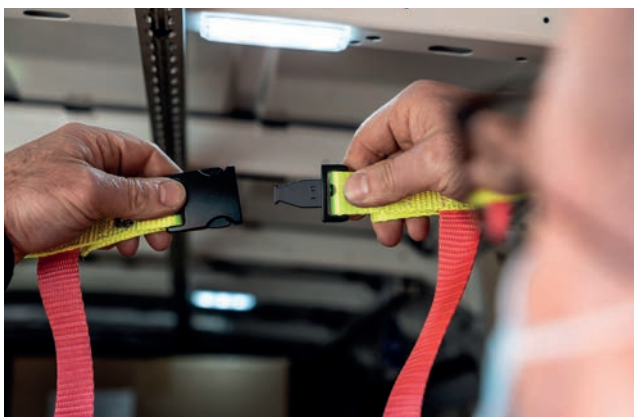
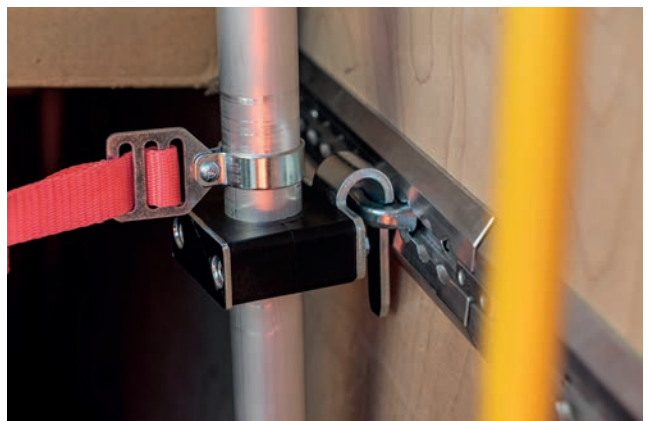

"QuickKEP" dimensions

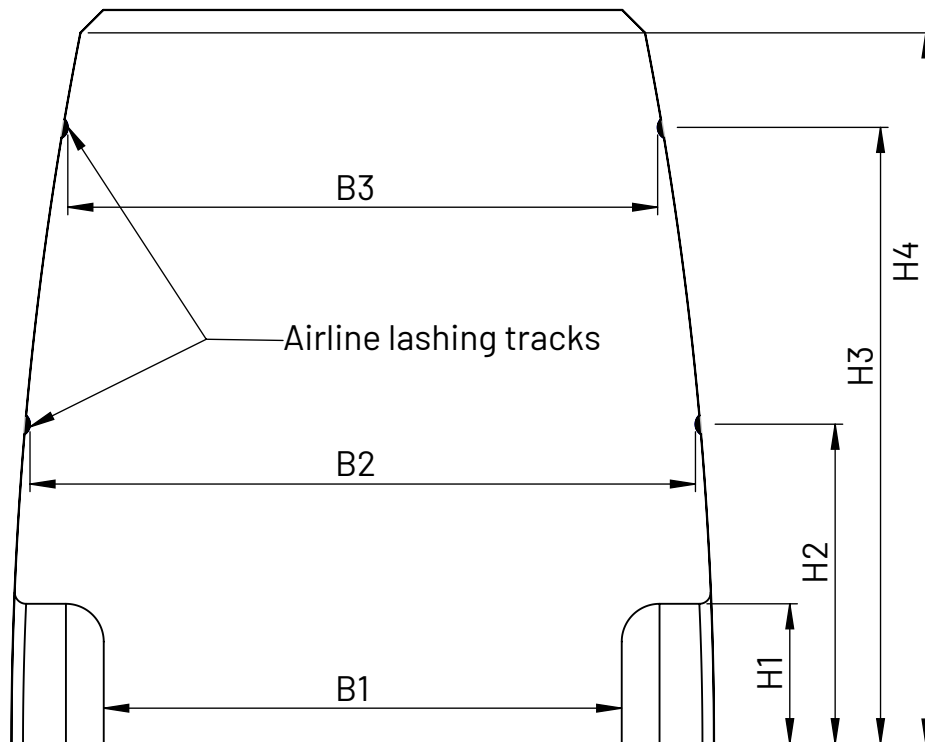

company	
vehicle manufacturer	
vehicle model	
H1	
B1	
H2	
B2	
B3	
H3	
H4	

[Click here for the online form.](#)

"QuickMED" medium cargo securing net



Technical data

- > suitable for Citroën Jumpy, Fiat Talento, Ford Transit Connect, MB Vito, Opel Vivaro, Renault Trafic, VW T5 / T6, as well as other models
- > vertical pickup truck load safety net
- > is locked by spring pressure on the bottom pin in the hooking device
- > strap width: 25 mm
- > with aluminum rods both sides
- > 2 mounting levels for hanging up
- > LC net mounting point 250 daN
- > LC net total 600 daN
- > mesh check, production and marking according to VDI guideline 2700 Part 3.3
- > net height approx. 1,200 mm
- > weight net: approx. 4.8 kg
- > weight fitting 380 total: approx. 900 g

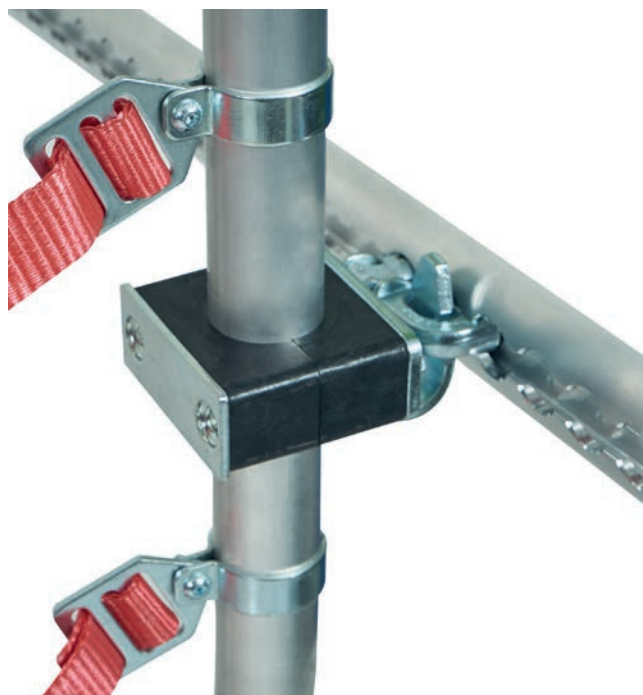

Side mounting

- > WIS hook-in device for double airline fitting 380
- > 8 double airline fittings are already included in the set

Packed as a set

Designation	Item number
Safeguard cargo securing net QuickMed Mercedes Vito	274290000100



"QuickMED" small cargo securing net



Technical data

- > suitable for Citroën Berlingo, Fiat Doblo, Ford Transit Courier, MB Citan, Opel Combo, Renault Kango, VW Caddy, as well as other models
- > vertical pickup truck load safety net
- > is locked by spring pressure on the bottom pin in the hooking device
- > strap width: 25 mm
- > with aluminum rods both sides
- > 2 mounting levels for hanging up
- > LC net mounting point 250 daN
- > LC net total 600 daN
- > mesh check, production and marking according to VDI guideline 2700 Part 3.3
- > net height approx. 1,080 mm
- > weight net: approx. 4,3 kg
- > weight fitting 380 total: approx. 900 g

Side mounting

- > WIS hook-in device for double airline fitting 380
- > 8 double airline fittings are already included in the set

Packed as a set

Designation	Item number
Safeguard cargo securing net QuickSmall Citroen Berlingo	274290000200



"QuickMED" medium und small dimensions

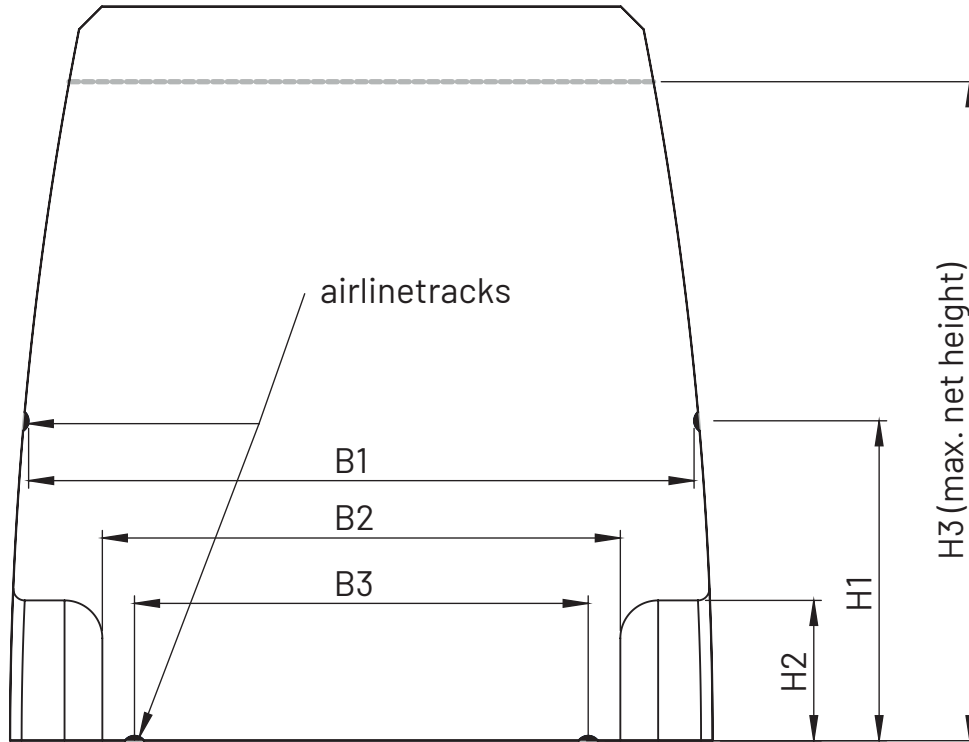

company	
vehicle manufacturer	
vehicle model	
H1	
B1	
H2	
B2	
H3	
B3	

[Click here for the online form.](#)

Cargo securing net "4 levels"



Technical data

- > for MB Sprinter / VW Crafter Height 2
- > vertical transport net
- > strap width: 25 mm
- > strap colour: red
- > mesh size approx. 175 x 175 mm.
- > 4 mounting levels
- > width approx. 1,450/1,700 mm x height approx. 1,700 mm
- > LC net mounting point 200 daN
- > LC net total 400 daN
- > mesh check, production and marking according to VDI guideline 2700 Part 3.3
- > net height approx. 1,800 mm

The following end fittings are included per box:

- > 8 x end fitting 382 for airline lashing tracks
- > 8 x end fitting 025 for track with pins

Side mounting

- > on both sides by means of attached clamp lock
- > four mounting levels measured from the floor approx. 50 mm / 700 mm / 1,540 mm / 1,800 mm
- > net width
 - mounting level with approx. 50 mm: approx. 1,600 mm,
 - mounting level with approx. 700 mm: approx. 1,600 mm
 - mounting level with approx. 1,540 mm: approx. 1,400 mm
 - mounting level with approx. 1,800 mm: 1,350 mm

Packed as a set

Designation	Item number
Safeguard cargo securing net 25 Crafter/Sprinter 4 levels	271350000008

WISTRA alcove netting

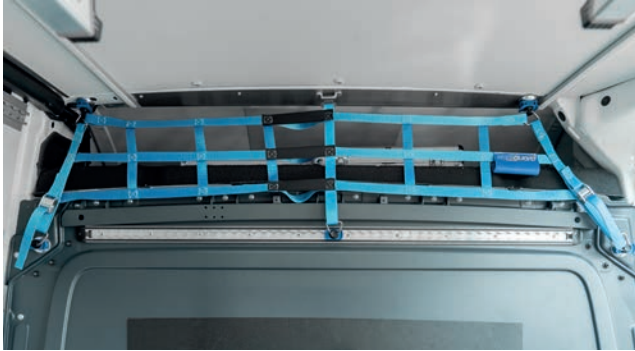

Technical data

- > load securing net for the storage space above the cab
- > adapted to the contour of the MB Sprinter - Hight 2
- > strap width: 25 mm
- > strap colour: blau
- > LC net mounting point 200 daN
- > LC net total 150 daN
- > mesh check, production and marking according to VDI guideline 2700 Part 3.3
- > net height approx. 215 mm
- > weight net: 900 g
- > attachment with 5x fitting 382 and hook 213
- > 5x round airline attachment points, 1x flat hook as well as 1x hooks and clamps are included in the set

Packed as a set

Designation	Item number
Safeguard Ladungssicherungsnetz Alkoven Sprinter Set	2743101

Cargo securing net for tie-down lashing with ratchets



Technical data

- > size: 1,575 x 1,350 mm
- > mesh size: 200 x 200 mm
- > strap width: 25 mm wide
- > strap colour: red
- > 14 D-rings 703 are sewn circumferentially around the net
- > additionally 4 end fittings 025 on each of the short sides
- > including 4 fastening straps WTR 1000 single-part 4.0 m red
- > including 4 freewheeling standard claw hooks 002
- > mesh check, production and marking according to VDI guideline 2700 Part 3.3
- > LC net mounting point 500 daN
- > LC net total 800 daN

Packed as a set

Designation	Item number
Safeguard cargo securing net 1,575 x 1,350 mesh width 200	272130000000

Cargo securing net for low tensioning with cam buckles



Technical data

- > size: 1,375 x 1,225 mm
- > mesh size: 125 x 125 mm
- > strap width: 25 mm
- > strap colour: blue
- > 1 end fitting 025 at each corner
- > additionally 4 end fittings 025 tapering inwards inside net
- > for adaptation with cam buckle 605 and long end with end fitting 025 length 1.0 m
- > cam buckles and long ends are included in the net
- > mesh check, production and marking according to VDI guideline 2700 Part 3.3
- > LC net mounting point 340 daN
- > LC net total 480 daN

Packed as a set

Designation	Item number
Safeguard cargo securing net 1,375 x 1,225 mesh width 125	272220000001

Cargo securing net for tensioning down

1

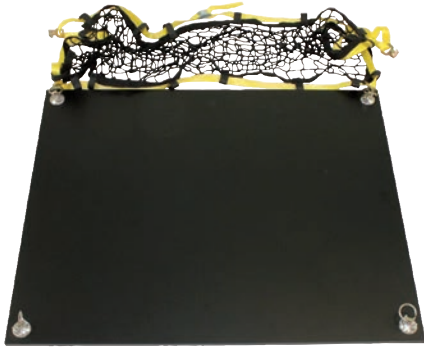

2



3



4



Technical data

Consisting of:

- > 1 x cargo securing net
basis of VDI 2700 Part 3.3
material: knitted yarn
material thickness: 3 mm
mesh size approx. 45 mm.
maximum mesh tensile force: approx. 1,250 N
yarn colour: black
all around with edging tape in black
and 36 strap loops
- > 1 x WTK 500 single-part 7,800 mm yellow
- > 4 x end fitting **002** (claw hook) / **725** (S-hook with PVC cover) / **201** (flat snap hook) / **025** (flat hook with safety mechanism) / **382** (single airline fitting)
- > LC net total: 400 daN
- > LC net mounting point: 350 daN
- > packaging: bagged with sticker

- > size: 1,290 x 730 mm

Designation	Item number
Safeguard cargo securing net 1,250 x 730 knitted WTK claw hook 002 yellow	272830002210
Safeguard cargo securing net 1,250 x 730 knitted WTK S-hook 725 yellow	272830725210
Safeguard cargo securing net 1,250 x 730 knitted WTK flat snap hook 201 yellow	272830201210
Safeguard cargo securing net 1,250 x 730 knitted WTK flat hook 025 yellow	272830025210
Safeguard cargo securing net 1,250 x 730 knitted WTK airline fitting 382 yellow	272830382210

- > size: 2,290 x 1,500 mm

Designation	Item number
Safeguard cargo securing net 2,290 x 1,500 knitted WTK claw hook 002 yellow	272940002210
Safeguard cargo securing net 2,290 x 1,500 knitted WTK S-hook 725 yellow	272940725210
Safeguard cargo securing net 2,290 x 1,500 knitted WTK flat snap hook 201 yellow	272940201210
Safeguard cargo securing net 2,290 x 1,500 knitted WTK flat hook 025 yellow	272940025210
Safeguard cargo securing net 2,290 x 1,500 knitted WTK airline fitting 382 yellow	272940382210



WISTRA WheelNet

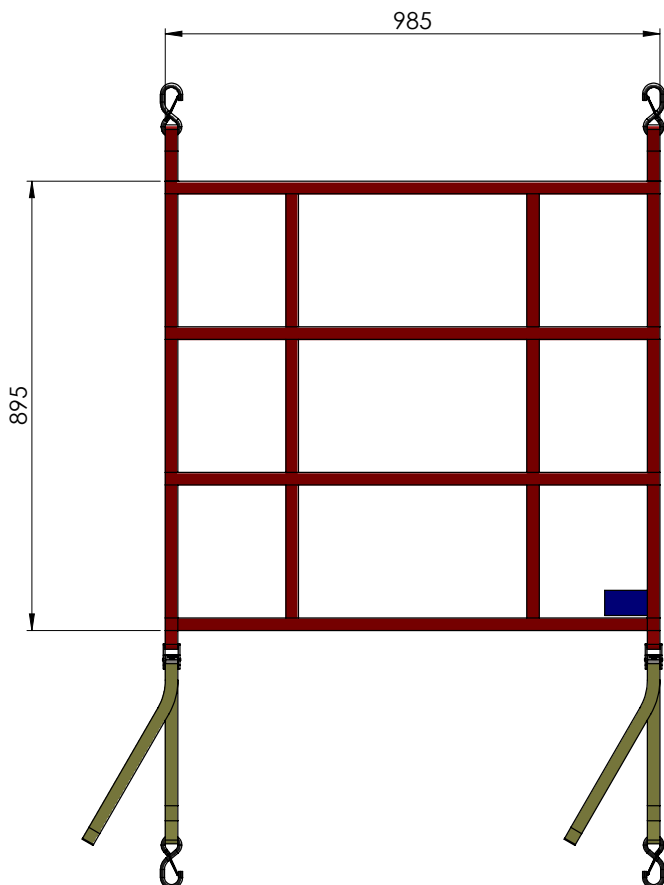
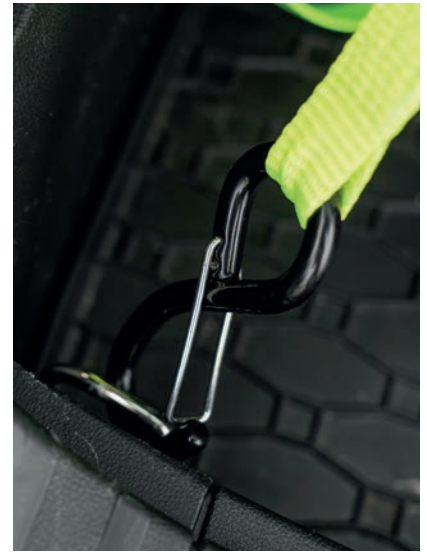

Technical data

- > size: 985 x 895 mm
- > strap width: 25 mm
- > strap colour: rot
- > 4 x S-hook (with PVC cover) with safety clip
- > 2 x cam buckle 25 mm
- > Cam buckles and yellow webbing will be fixed at the end of the vehicle and can be tighten.

Designation	Item number
Safeguard wheel net for trunk	274300000000

Covering nets

Technical data

- > cover net made of PPM knotless
- > according to VDI 2700, sheet 3.3
- > mesh size: 30 x 30 mm
- > material thickness: 2 mm
- > net colour: green
- > with edge hem and circumferential rubber rope

Designation	Item number
Covering net with 6 mm rubber cord around edge 2 mm MW 30 1.8 x 3.3 m	275200313318
Covering net with 6 mm rubber cord around edge 2 mm MW 30 2.0 x 3.0 m	275200312030
Covering net with 6 mm rubber cord around edge 2 mm MW 30 2.0 x 3.5 m	275200312035
Covering net with 6 mm rubber cord around edge 2 mm MW 30 2.5 x 3.5 m	275200313525
Covering net with 6 mm rubber cord around edge 2 mm MW 30 2.5 x 4.5 m	275200314525
Covering net with 6 mm rubber cord around edge 2 mm MW 30 4.5 x 3.0 m	275200314530

- > cover net made of PPM knotless
- > according to VDI 2700, sheet 3.3
- > mesh size: 50 x 50 mm
- > material thickness: 3 mm
- > net colour: green
- > with edge hem and circumferential rubber rope

Designation	Item number
Covering net with 6 mm rubber cord around edge 3 mm MW 50 1.5 x 2.2 m	275300511522
Covering net with 6 mm rubber cord around edge 3 mm MW 50 1.5 x 2.5 m	275300511525
Covering net with 6 mm rubber cord around edge 3 mm MW 50 1.5 x 2.7 m	275300512715
Covering net with 6 mm rubber cord around edge 3 mm MW 50 2.0 x 3.0 m	275300512030
Covering net with 6 mm rubber cord around edge 3 mm MW 50 2.5 x 3.5 m	275300512535
Covering net with 6 mm rubber cord around edge 3 mm MW 50 2.5 x 4.5 m	275300514525
Covering net with 6 mm rubber cord around edge 3 mm MW 50 3.0 x 3.5 m	275300513035
Covering net with 6 mm rubber cord around edge 3 mm MW 50 3.0 x 4.0 m	275300513040
Covering net with 6 mm rubber cord around edge 3 mm MW 50 3.5 x 5.0 m	275300513550
Covering net with 6 mm rubber cord around edge 3 mm MW 50 3.5 x 5.5 m	275300515535
Covering net with 6 mm rubber cord around edge 3 mm MW 50 3.5 x 6.0 m	275300513560
Covering net with 6 mm rubber cord around edge 3 mm MW 50 3.5 x 7.0 m	275300513570
Covering net with 6 mm rubber cord around edge 3 mm MW 50 3.5 x 8.0 m	275300513580

106

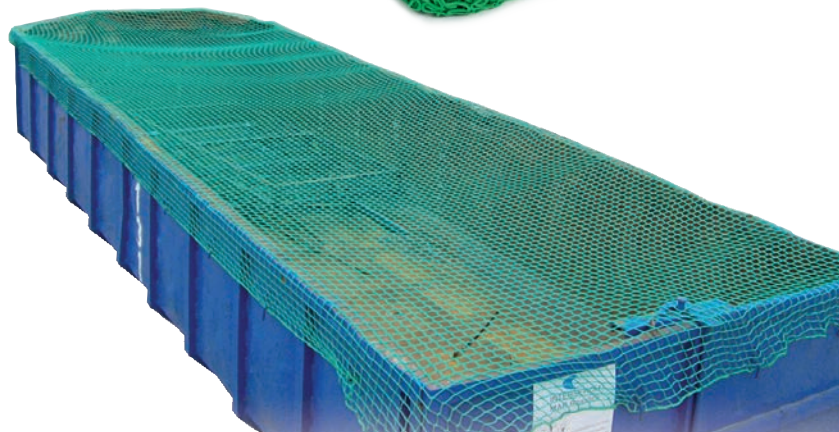
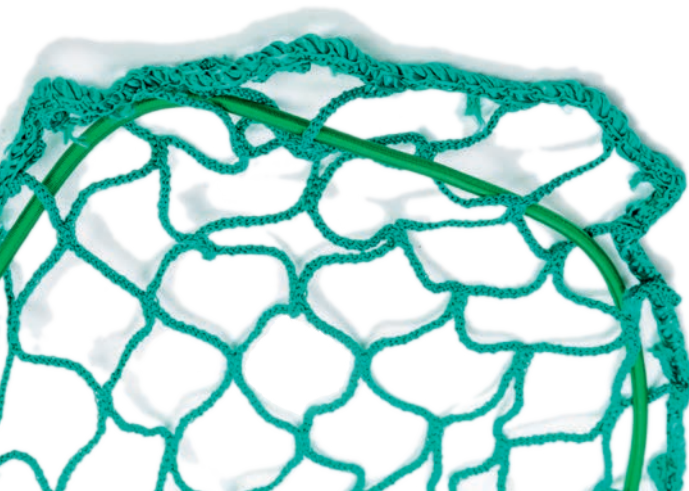

Shoring beam PEN-BEAM

Product description

The WISTRA PEN-BEAM is equipped with innovative gas pressure springs that exert a uniform and defined pressure on the vehicle superstructure across the entire telescopic range.

The special engaging function in the telescopic tube enables ergonomic operation. In the engaged position, the PEN-Beam is shorter than the width of the vehicle, which makes handling easy. All PEN-BEAM variants can be ordered with a robust PVC sheathing. All versions can be configured to suit the particular interior vehicle dimensions and are equipped to match the specific lashing track type.

Designation	Item number
Shoring beam type 1870 PEN-BEAM aluminium 09	221870020920-2250
Shoring beam type 1870 PEN-BEAM aluminium 09 with coating	221870020920Ü-2250

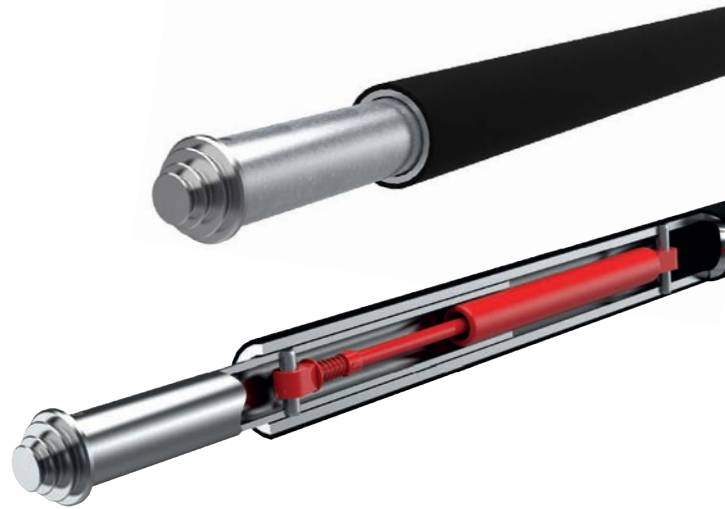

Version: 09
19 mm pin

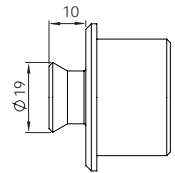

When retracted and locked the WISTRA PEN-BEAM is shorter than the inside dimensions of the vehicle and this enables an ergonomic use.



The WISTRA PEN-BEAM is unlocked by slight pressure on the telescopic tube.



The telescopic tube moves slowly into the lashing track and with constant pressure. This minimizes the risk of damage to the vehicle body.

Shoring beam "Airline Beam" 1855

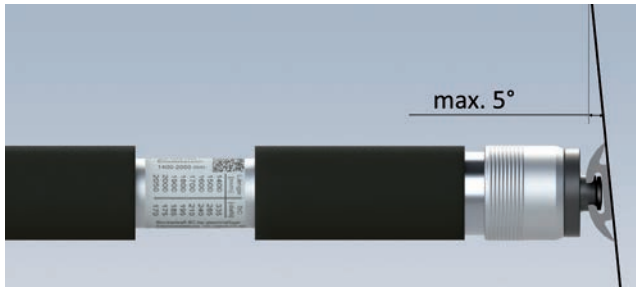

Product description

Used in conjunction with airline lashing tracks running parallel in the vehicle, the trailer or other means of transport, the Airline Beam ensures cargo securing with positive locking. The Airline Beam can be used horizontally and vertically for cargo securing. The automatic airline pins on both sides snap into one pair of holes in each of the airline lashing tracks.

1. unlocking

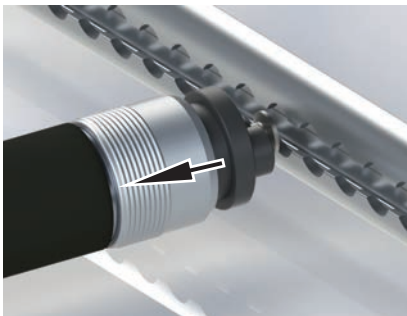

2. inserting

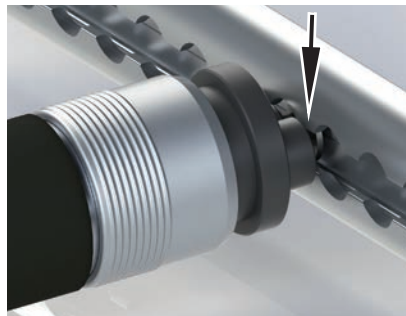

3. shifting

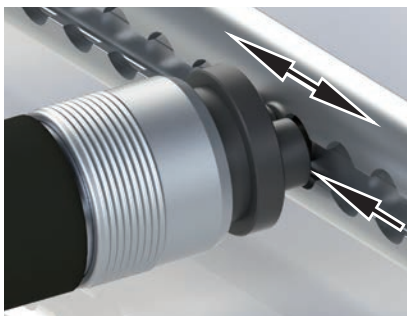

4. locking

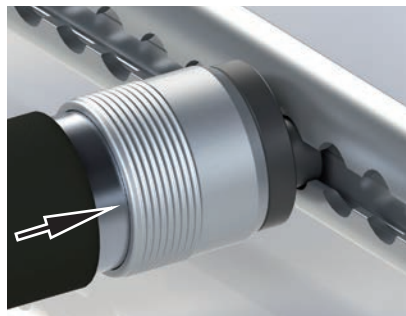

Example of a label:
Can be customised with your logo and your address on request!

Advantages

- suited for horizontal and vertical application
- In conjunction with non-slip materials, cargo with a weight of up to 2,250 kg can be secured in the direction of travel using one Airline Beam.
- smooth and continuous telescopic adjustment
- no protruding operating controls over its entire range
- supporting tube and hand piece with PVC coating for comfortable handling even in cold outside temperatures, as well as for protection of the load
- The automatic airline pins on both sides snap into one pair of holes in each of the airline lashing tracks.
- The automatic airline pins do not damage the material within the airline lashing track.
- When the Airline Beam is inserted by the user, no simultaneous pressure in both directions is required.
- The airline automatic spigot is prevented from slipping out by a locking mechanism activated by applying pressure to the side panel.
- Thanks to the locking mechanism in the airline lashing track, the system does not damage the transport vehicle.



Shoring beam "Airline Beam" 1855



Technical data

- > with PVC coating in black
- > support tube diameter: 42 mm
- > both sides with innovative automatic pin for the airline lashing track

- > with pull-out stop for 150 mm telescopic distance

Designation	possible field of application	Blocking capacity	Item number
Shoring beam Airline-Beam type 1855 650 black pull-out 150 mm	650 - 760 mm	550 - 675 daN	221855-150-0650
Shoring beam Airline-Beam type 1855 800 black pull-out 150 mm	800 - 910 mm	475 - 600 daN	221855-150-0800

- > with pull-out stop for 350 mm telescopic distance

Designation	possible field of application	Blocking capacity	Item number
Shoring beam Airline-Beam type 1855 900 black pull-out 350 mm	900 - 1,210 mm	350 - 575 daN	221855-350-0900
Shoring beam Airline-Beam type 1855 1,000 black pull-out 350 mm	1,000 - 1,310 mm	325 - 550 daN	221855-350-1000

Shoring beam "Airline Beam" 1855



Technical data

- > with PVC coating in black
- > support tube diameter: 42 mm
- > both sides with innovative automatic pin for the airline lashing track
- > with pull-out stop for 600 mm telescopic distance

Designation	possible field of application	Blocking capacity	Item number
Shoring beam Airline-Beam type 1855 1,100 black pull-out 600 mm	1.100 - 1.660 mm	250 - 550 daN	221855-600-1100
Shoring beam Airline-Beam type 1855 1,200 black pull-out 600 mm	1.200 - 1.760 mm	225 - 525 daN	221855-600-1200
Shoring beam Airline-Beam type 1855 1,300 black pull-out 600 mm	1.300 - 1.860 mm	225 - 525 daN	221855-600-1300
Shoring beam Airline-Beam type 1855 1,400 black pull-out 600 mm	1.400 - 1.960 mm	225 - 500 daN	221855-600-1400
Shoring beam Airline-Beam type 1855 1,500 black pull-out 600 mm	1.500 - 2.060 mm	200 - 450 daN	221855-600-1500
Shoring beam Airline-Beam type 1855 1,600 black pull-out 600 mm	1.600 - 2.160 mm	200 - 425 daN	221855-600-1600
Shoring beam Airline-Beam type 1855 1,700 black pull-out 600 mm	1.700 - 2.260 mm	200 - 400 daN	221855-600-1700
Shoring beam Airline-Beam type 1855 1,800 black pull-out 600 mm	1.800 - 2.360 mm	200 - 375 daN	221855-600-1800
Shoring beam Airline-Beam type 1855 1,900 black pull-out 600 mm	1.900 - 2.460 mm	200 - 350 daN	221855-600-1900

Storage rail for "Airline Beam"



Technical data

- > material: steel, black black KTL coated
- > to be fastened to the airline rail with a screw fitting
- > Set consists of 2 parking angles, 2 star handles with Airline screws 8 x 25
- > W x H x D: 79 x 120 x 50 mm

Designation	Item number
Parking device for airline beam set black	215110010



Aluminum shoring beam modular system

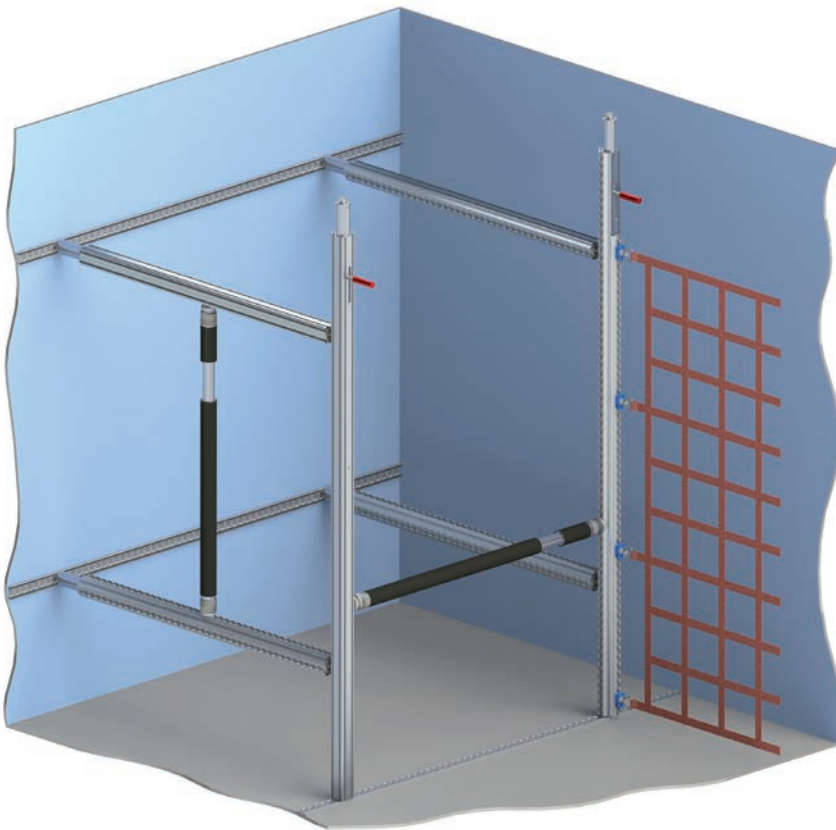

Strength meets individuality

The new WISTRA shoring beam system is based on a new 50 x 50 mm aluminum profile. In the design phase, the focus was on the many customer requests we received.

Blocking forces BC of up to 900 daN were achieved at our in-house testing facility, depending on the version.

Its true strength is its versatility and individual connection options to the inserted airline sliding profile.

In addition to the Airline Beam 1855, WISTRA lashing straps as well as Safe-guard cargo securing nets or further accessories for the airline lashings can be used.

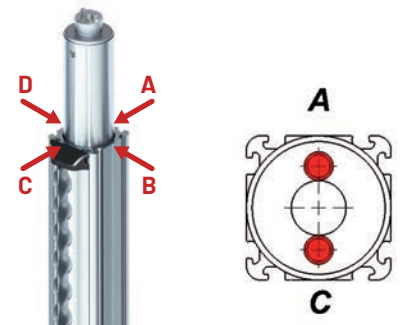
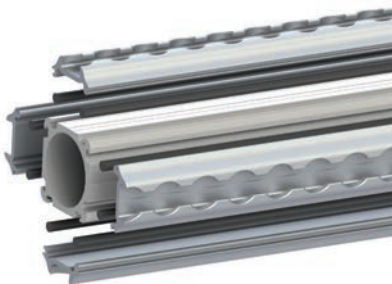

The supporting tube

The new square shoring beams can be equipped in their basic form or additionally with inserted airline lashing tracks or with rubber protection along their entire length or in sections.

The connection systems

In addition to the design features of the supporting tube, we offer the shoring beams with the proven compression spring telescopic tubes for perforated rail systems or freely telescopic without compressive forces with the WISTRA-Airline automatic pin in conjunction with the airline lashing tracks.

Version secured against rotation

The pin version with anti-twist protection type 19 + type 25, the pin is mounted lengthways from side A to side C.

Aluminum "Spairbalken 1851" (shoring beam)

with compression spring telescope and handle

Pin design

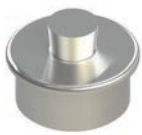

Type 09



Type 19
non-rotating
Ensure correct
positioning!



Type 24



Type 25
non-rotating
Ensure correct
positioning!



for lashing track



Hole pitch
ø 20 mm



Airline version



Hole pitch
ø 25 mm



Combi track
ø 25 mm

Aluminum "Spairbalken 1857" (shoring beam)

with compression spring telescope

Pin design

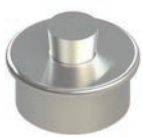

Type 09



Type 19
non-rotating
Ensure correct
positioning!



Type 24



Type 25
non-rotating
Ensure correct
positioning!



Type 32



for lashing track



Hole pitch
ø 20 mm



Airline version



Hole pitch
ø 25 mm



Combination
track ø 25 mm



Keyhole 34/22

The WISTRA sprinter on tour



Aluminum shoring beam 1856 telescopic

Product description

The shoring beam is used in conjunction with airline lashing tracks running parallel in the vehicle, trailer or other means of transport to ensure cargo securing with positive locking. The shoring beam can be used both horizontally and vertically for securing cargo. The automatic airline pins on both sides snap into one pair of holes in each of the airline lashing tracks.

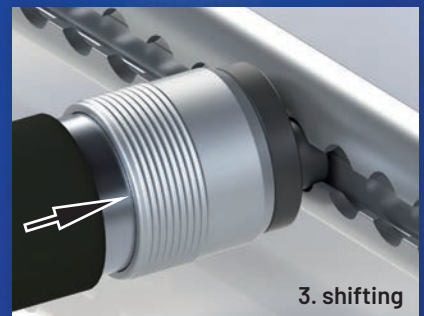
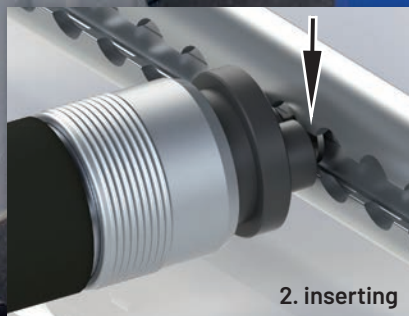

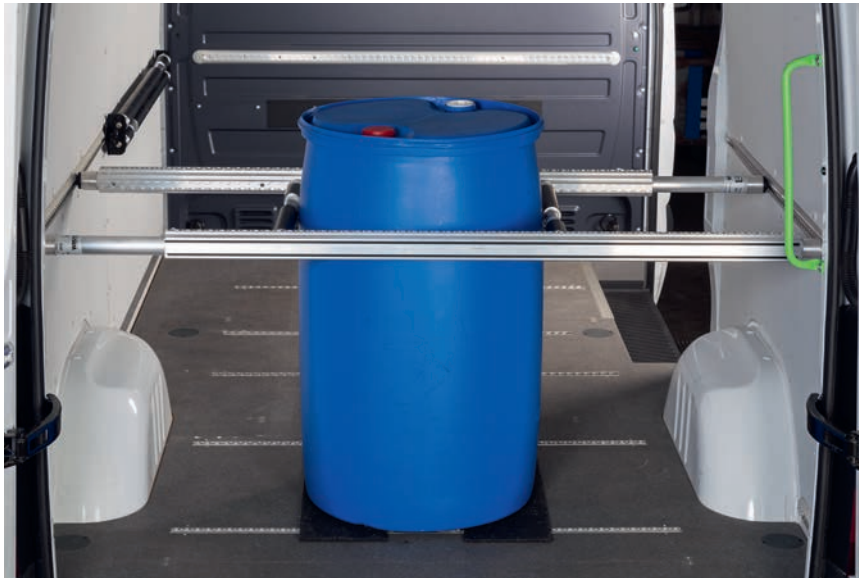
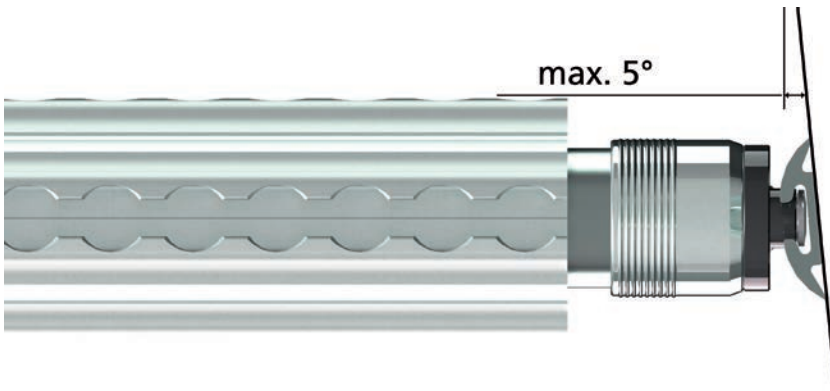

horizontal application



vertical application

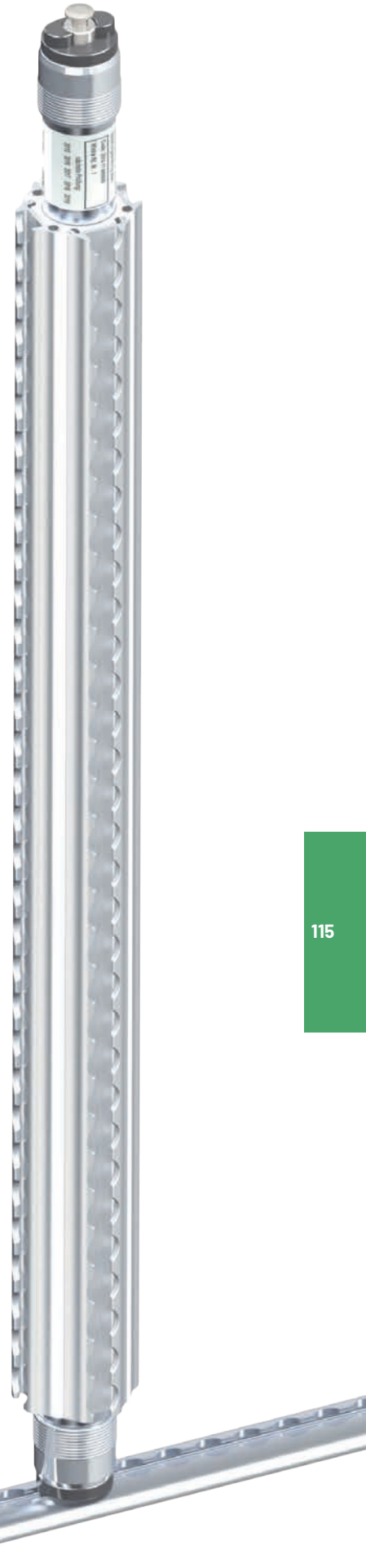

Aluminum parting wall lock for trailers



Technical data

- > application range: 1,250 – 1,550 mm / 1,500 – 1,800 mm / 2,100 – 2,400 mm
- > max. blocking force: BC 400 daN for uniform area loading up to 2,700 mm

Designation	Item number
Parting wall lock for trailer alum. 1,250-1,550 mm	2374530-1250
Parting wall lock for trailer alum. 1,500-1,800 mm	2374530-1500
Parting wall lock for trailer alum. 2,100-2,400 mm	2374530-2100

Garment rail TA for airline lashing tracks



Technical data

- > with the aid of 2 double-airline end fittings 380 (incl.), it snaps clothes rails into airline lashing tracks
- > **area of application: must be specified with each enquiry or order**
- > support tube: chrome-plated
- > without spring function
- > equipped with two Velcro straps for securing the throw bar

Designation	Item number
Garment rail type TA for transporters according to specification	26750-XXXX



Hang the garment rail in the double airline fitting



Double airline fitting 380

Carbon "QuickWall" cargo securing wall

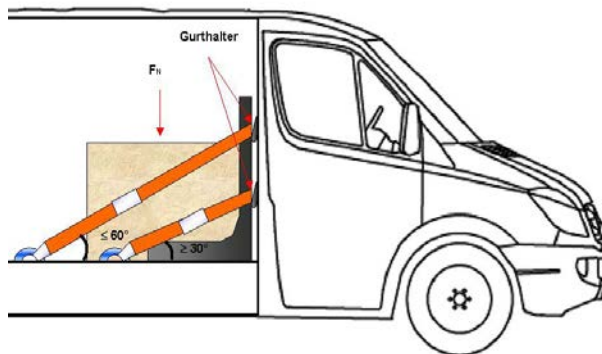

QR-Code ein-scannen und Video anschauen

Technical data

- > in conjunction with the lashing straps used on two levels in the means of transport ensures cargo securing with positive locking
- > made of high-quality carbon fibre material
- > colour: black
- > W x H x D: 1,190 x 800 x 360 mm
- > weight: approx. 12 kg
- > DEKRA-certified (No. 201432956 dated 17/10/2014)
- > use with RH mats and lashing straps LC 1000 daN easy and straightforward
- > the max. total payload of the QuickWall is 1,400 kg

As a set incl. 2 lashing straps WTR 2200-520 0.5 + 5.5 m and 2x non-slip mat roll 1,250 x 3 x 150 mm

Designation	Item number
Carbon wall cargo securing wall set "Quick Wall"	16920000





Top seller

Car transport lashing strap WTA 2908

More on page 123



Cargo securing for car transporters and trailers

Protection for long end



Type A50
Rubberised hose



Type B50
Fabric hose



Type D50
3 pieces abra-
sion blocks

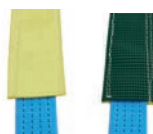

Type E50
Controller with rub-
berised backside

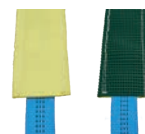

Type E35
Controller with rub-
berised backside

Car transport lashing strap WTA 3821



Type A50



Type B50



Type D50

Technical data

- > according to EN 12195-2 elongation max. 4%
- > strap width 50 mm
- > LC 1,500 daN with straight tension
- > short end with end fitting **006** (claw hook)
- > free-running end fitting **006** (claw hook)
- > long end with end fitting **006** (claw hook)
- > strap colour: blue

Designation	Item number
Car transport belt WTA 3821A50 006 claw hook 006 claw hook 006 SE 0.2 + LE 2.8 blue 4%	1500380

Designation	Item number
Car transport belt WTA 3821B50 006 claw hook 006 claw hook 006 SE 0.2 + LE 2.8 blue 4%	1503152

Designation	Item number
Car transport belt WTA 3821D50 006 claw hook 006 claw hook 006 SE 0.2 + LE 2.5 blue 4%	11811050060225

Car transport lashing strap WTA 3821



Type E50

Technical data

- › according to EN 12195-2 elongation max. 4%
- › strap width 50 mm
- › LC 1,500 daN with straight tension
- › ratchet 821 with end fitting **353** (swivel hook)
- › free-running end fitting **014** (single finger claw hook)
- › long end with end fitting **014** (single finger claw hook)
- › strap colour: blue

Designation	Item number
Car transport belt WTA 3821E50 swivel hook 353 1-finger hook 014 1-finger hook 014 SE 2.3 blue 4%	1503184

Car transport lashing strap WTA 3921



Type E35

Technical data

- › according to EN 12195-2 elongation max. 4%
- › strap width 35 mm
- › LC 1,500 daN with straight tension
- › short end with end fitting **356** (swivel hook)
- › free-running end fitting **354** (swivel hook)
- › long end with end fitting **354** (swivel hook)
- › loose end with securing seam
- › strap colour: blue
- › label inside, with Quick-View-Label

Designation	Item number
Car transport belt WTA 3921E35 swivel hook 356 + 354 SE 2.8 blue 4%	1351023

Car transport lashing strap WTA 2917



Technical data

- > according to EN 12195-2
- > LC 1,000 daN with straight tension
- > short end with end-fitting **536** (single finger claw hook)
- > without free-running end fitting
- > long end with end fitting **536** (single finger claw hook)
- > without protective hose
- > strap colour: orange
- > including blue cross-strap (figure-eight loop)
- > both sides loop 100 mm – **tapered**
- > total length DP/DP 351 mm

Designation	Item number
Car transport belt WTA 2917035 1-finger claw hook 536 SE 0.2 + LE 2.5 blue	1357412

Car transport lashing strap WTA 2908



Technical data

- > according to EN 12195-2
- > LC 1000 daN with straight tension
- > SE with end fitting **356** (swivel hook) directly on the ratchet
- > long end with end fitting **015** (D-ring) and protective hose 400 mm
- > measured from the hook with a length of 500 mm, a fitted EB 536 (single-finger claw hook)
- > strap colour: blue

Designation	Item number
Car transport belt WTA 2921035 swivel hook 356 D-ring 015 SE 1.5	1351235L



Top seller

Hoisting strap

More on page 125



Other products

Lifting slings



Technical data

- > nominal load capacity: 1,000 kg
- > width: 30 mm
- > colour: violet
- > according to EN 1492-1
- > GS-tested

Designation	Item number
Lifting strap 1 t violet 2.0 m	620100203021
Lifting strap 1 t violet 4.0 m	620100403021
Lifting strap 1 t violet 6.0 m	620100603021



Technical data

- > nominal load capacity: 2,000 kg
- > width: 60 mm
- > colour: green
- > according to EN 1492-1
- > GS-tested

Designation	Item number
Lifting strap 2 t green 2.0 m	620100206021
Lifting strap 2 t green 4.0 m	620100406021
Lifting strap 2 t green 6.0 m	620100606021
Lifting strap 2 t green 8.0 m	620100806021



Technical data

- > nominal load capacity: 3,000 kg
- > width: 90 mm
- > colour: yellow
- > according to EN 1492-1
- > GS-tested

Designation	Item number
Lifting strap 3t yellow 2.0 m	620100209021
Lifting strap 3t yellow 4.0 m	620100409021
Lifting strap 3t yellow 6.0 m	620100609021

Lifting slings



Technical data

- > nominal load capacity: 4,000 kg
- > width: 120 mm
- > colour: grey
- > according to EN 1492-1
- > GS-tested

Designation	Item number
Lifting strap 4 t grey 2.0 m	620100212021
Lifting strap 4 t grey 4.0 m	620100412021
Lifting strap 4 t grey 6.0 m	620100612021



Technical data

- > nominal load capacity: 6,000 kg
- > width: 180 mm
- > colour: brown
- > according to EN 1492-1
- > GS-tested

Designation	Item number
Lifting strap 6 t brown 6.0 m	620100618021

Round slings



Technical data

- > nominal load capacity: 1,000 kg
- > useful length: 0.5 – 4.0 m
- > circumferential length: 1.0 – 8.0 m
- > colour: violet
- > according to EN 1492-2
- > GS-tested

Designation	Item number
Round sling 1 t violet 1.0 m circumference	610100100027
Round sling 1 t violet 2.0 m circumference	610100200027
Round sling 1 t violet 3.0 m circumference	610100300027
Round sling 1 t violet 4.0 m circumference	610100400027
Round sling 1 t violet 5.0 m circumference	610100500027
Round sling 1 t violet 6.0 m circumference	610100600027
Round sling 1 t violet 8.0 m circumference	610100800027



Technical data

- > nominal load capacity: 2,000 kg
- > useful length: 0.5 – 4.0 m
- > circumferential length: 1.0 – 8.0 m
- > colour: green
- > according to EN 1492-2
- > GS-tested

Designation	Item number
Round sling 2 t green 1.0 m circumference	610200100027
Round sling 2 t green 2.0 m circumference	610200200027
Round sling 2 t green 3.0 m circumference	610200300027
Round sling 2 t green 4.0 m circumference	610200400027
Round sling 2 t green 5.0 m circumference	610200500027
Round sling 2 t green 6.0 m circumference	610200600027
Round sling 2 t green 8.0 m circumference	610200800027

Round slings



Technical data

- > nominal load capacity: 3,000 kg
- > useful length: 0.5 – 4.0 m
- > circumferential length: 1.0 – 8.0 m
- > colour: yellow
- > according to EN 1492-2
- > GS-tested

Designation	Item number
Round sling 3 t yellow 1.0 m circumference	610300100027
Round sling 3 t yellow 2.0 m circumference	610300200027
Round sling 3 t yellow 3.0 m circumference	610300300027
Round sling 3 t yellow 4.0 m circumference	610300400027
Round sling 3 t yellow 5.0 m circumference	610300500027
Round sling 3 t yellow 6.0 m circumference	610300600027
Round sling 3 t yellow 8.0 m circumference	610300800027



Technical data

- > nominal load capacity: 4,000 kg
- > useful length: 1.0 – 4.0 m
- > circumferential length: 2.0 – 8.0 m
- > colour: grey
- > according to EN 1492-2
- > GS-tested

Designation	Item number
Round sling 4 t grey 2.0 m circumference	610400200027
Round sling 4 t grey 4.0 m circumference	610400400027
Round sling 4 t grey 6.0 m circumference	610400600027
Round sling 4 t grey 8.0 m circumference	610400800027



Technical data

- > nominal load capacity: 6,000 kg
- > useful length: 2.0 – 4.0 m
- > circumferential length: 4.0 – 8.0 m
- > colour: brown
- > according to EN 1492-2
- > GS-tested

Designation	Item number
Round sling 6 t brown 4.0 m circumference	610600400027
Round sling 6 t brown 6.0 m circumference	610600600027
Round sling 6 t brown 8.0 m circumference	610600800027

Container seal cinch-up seal S 306

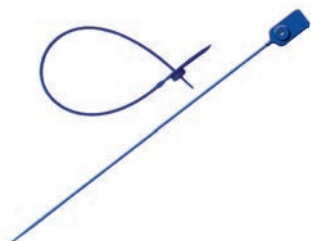

Technical data

- > length: 375 mm
- > VPE: 1,000 pieces

Designation	Item number
Seal cinch-up seal S 306 length 375 mm	0340306

Container seal clicker



Technical data

- > pin diameter: 9 mm
- > locking length: 45 mm

Designation	Item number
Seal clicker	0342211

Ratchets



Technical data

- > material: steel galvanised
- > LC: 2500 daN
- > STF: 704 / 550 daN
- > lifting length: 350 mm

Designation	Webbing width	Item number
Ratchet type 818	50 mm	128180000013



Technical data

- > material: steel galvanised
- > LC: 2500 daN
- > STF: 500 daN
- > lifting length: 310 mm

Designation	Webbing width	Item number
Ratchet type 822	50 mm	128220000013



Technical data

- > material: steel galvanised
- > LC: 2500 daN
- > STF: 300 daN
- > lifting length: 200 mm

Designation	Webbing width	Item number
Ratchet type 811/13KG	50 mm	128110000013KG



Technical data

- > material: steel / plastic
- > LC: 2500 daN
- > STF: 300 daN
- > lifting length: 200 mm

Designation	Webbing width	Item number
Ratchet type 811/20	50 mm	1281100000050



Technical data

- > material: steel galvanised
- > LC: 2500 daN
- > STF: 300 daN
- > lifting length: 195 mm

Designation	Webbing width	Item number
Ratchet type 819	50 mm	128190000013



Technical data

- > material: steel galvanised
- > LC: 2500 daN
- > STF: 250 daN
- > lifting length: 170 mm

Designation	Webbing width	Item number
Ratchet type 823	50 mm	128230000013



Technical data

- > material: steel galvanised
- > LC: 1000 daN
- > STF: 210 daN
- > lifting length: 105 mm

Designation	Webbing width	Item number
Ratchet type 916	50 mm	129160000013



Technical data

- > material: stainless steel
- > LC: 1000 daN
- > STF: 210 daN
- > lifting length: 105 mm

Designation	Webbing width	Item number
Ratchet type 916/30	50 mm	129160000030

Ratchets



Technical data

- > material: steel powder coated
- > LC: 1500 daN
- > STF: 240 daN
- > lifting length: 125 mm

Designation	Webbing width	Item number
Ratchet type 908	35 mm	129080000050



Technical data

- > material: steel galvanised
- > LC: 1500 daN
- > STF: 240 daN
- > lifting length: 140 mm

Designation	Webbing width	Item number
Ratchet type 921	35 mm	129210000013



Technical data

- > material: steel galvanised
- > LC: 1000 daN
- > STF: 200 daN
- > lifting length: 105 mm

Designation	Webbing width	Item number
Ratchet type 917	35 mm	129170000013



Technical data

- > Material: Stahl galvanisiert
- > LC: 750 daN
- > STF: 200 daN
- > Hebellänge: 100 mm

Designation	Webbing width	Item number
Ratchet type 915/13	25 mm	129150000013



Technical data

- > material: steel powder coated
- > LC: 750 daN
- > STF: 200 daN
- > lifting length: 95 mm

Designation	Webbing width	Item number
Ratchet type 915/50	25 mm	129150000050



Technical data

- > material: steel galvanised
- > LC: 400 daN
- > STF: 160 daN
- > lifting length: 90 mm

Designation	Webbing width	Item number
Ratchet type 906	25 mm	129060000013

Cam buckles



Technical data

- > material: zinc casting
- > LC-Wert: 5000 daN

Designation	Webbing width	Item number
Cam buckle type 907	50 mm	129070000012



Technical data

- > material: zinc casting
- > LC-Wert: 450 daN

Designation	Webbing width	Item number
Cam buckle type 835	35 mm	128350000020

Cam buckles



Technical data

- > material: zinc casting
- > LC: 250 daN

Designation	Webbing width	Item number
Cam buckle type 805	25 mm	128050000020



Technical data

- > material: zinc casting
- > LC: 175 daN

Designation	Webbing width	Item number
Cam buckle type 804/50	25 mm	128040000050



Technical data

- > material: zinc casting
- > LC: 175 daN

Designation	Webbing width	Item number
Cam buckle type 804/20	25 mm	128040000020

Double buckle



Technical data

- > material: steel powder coated
- > LC: 900 daN

Designation	Webbing width	Item number
Double buckle type 806/12	50 mm	128060000012



Technical data

- > material: steel powder coated
- > LC: 700 daN

Designation	Webbing width	Item number
Double buckle type 806/16	50 mm	128060000016

Overcenter buckle



Technical data

- > material: steel galvanised
- > LC: 750 daN

Designation	Webbing width	Item number
Overcenter buckle type 912	50 mm	128050000020



Technical data

- > material: steel galvanised
- > LC: 1125 daN

Designation	Webbing width	Item number
Overcenter buckle type 913	45 mm	129130000013



Technical data

- > material: stainless steel
- > LC: 712,5 daN

Designation	Webbing width	Item number
Overcenter buckle type 970	45 mm	129700000030

End fittings



Technical data

- > material: steel galvanised
- > LC: 2500 daN

Designation	Webbing width	Item number
Pointed hook	50 mm	140000000600



Technical data

- > material: steel galvanised
- > LC: 1500 daN

Designation	Webbing width	Item number
Pointed hook	50 mm	140000000700



Technical data

- > material: steel galvanised
- > LC: 1500 daN

Designation	Webbing width	Item number
Pointed hook	50 mm	140000035100



Technical data

- > material: steel galvanised
- > LC: 1500 daN

Designation	Webbing width	Item number
Pointed hook	50 mm	140000035300



Technical data

- > material: steel galvanised
- > LC: 1500 daN

Designation	Webbing width	Item number
Pointed hook	35 mm	140000035400



Technical data

- > material: steel
- > LC: 1500 daN

Designation	Webbing width	Item number
Pointed hook	35 mm	140000035600



Technical data

- > material: steel galvanised
- > LC: 1500 daN

Designation	Webbing width	Item number
Pointed hook	35 mm	140000052000



Technical data

- > material: steel galvanised
- > LC: 750 daN

Designation	Webbing width	Item number
Pointed hook	25 mm	140000000200

End fittings



Technical data

- > material: steel powder coated
- > LC: 750 daN

Designation	Webbing width	Item number
Pointed hook	25 mm	140000000250



Technical data

- > material: steel galvanised
- > LC: 2500 daN

Designation	Webbing width	Item number
Cranked pointed hook	50 mm	140000004600



Technical data

- > material: steel galvanised
- > LC: 2500 daN

Designation	Webbing width	Item number
Pointed hook with safety	50 mm	14000002060001



Technical data

- > material: steel galvanised
- > LC: 2500 daN

Designation	Webbing width	Item number
One finger claw hook	50 mm	140000001400



Technical data

- > material: steel galvanised
- > LC: 1500 daN

Designation	Webbing width	Item number
One finger claw hook	35 mm	140000053100



Technical data

- > material: steel galvanised
- > LC: 1250 daN

Designation	Webbing width	Item number
One finger claw hook	35 mm	140000053600



Technical data

- > material: steel galvanised
- > LC: 2500 daN

Designation	Webbing width	Item number
Flat hook	50 mm	140000001300



Technical data

- > material: steel galvanised
- > LC: 1500 daN

Designation	Webbing width	Item number
Flat hook	50 mm	140000001200

End fittings



Technical data

- > material: steel galvanised
- > LC: 650 daN

Designation	Webbing width	Item number
Flat hook	25 mm	140000002500



Technical data

- > material: steel galvanised
- > LC: 2500 daN

Designation	Webbing width	Item number
Claw hook	50 mm	140000006500



Technical data

- > material: steel/PVC coated
- > LC: 250 daN

Designation	Webbing width	Item number
S-Hook	25 mm	140000072500



Technical data

- > material: steel galvanised
- > LC: 1500 daN

Designation	Webbing width	Item number
Carabine hook	35 mm	140000053000



Technical data

- > material: steel galvanised
- > LC: 1000 daN

Designation	Webbing width	Item number
Carabine hook	35 mm	140000031100



Technical data

- > material: steel galvanised
- > LC: 680 daN

Designation	Webbing width	Item number
Carabine hook	25 mm	140000020100



Technical data

- > material: steel galvanised
- > LC: 2500 daN

Designation	Webbing width	Item number
Triangel carabine hook	50 mm	140000007500

End fittings



Technical data

- > material: steel
- > LC: 400 daN

Designation	Webbing width	Item number
Delta carabine hook	25 mm	140000020200



Technical data

- > material: steel galvanised
- > LC: 2500 daN

Designation	Webbing width	Item number
D-Ring	50 mm	140000001800



Technical data

- > material: steel galvanised
- > LC: 850 daN

Designation	Webbing width	Item number
D-Ring	50 mm	140000070500



Technical data

- > material: steel galvanised
- > LC: 1500 daN

Designation	Webbing width	Item number
D-Ring	35 mm	140000001500



Technical data

- > material: steel galvanised
- > LC: 1000 daN

Designation	Webbing width	Item number
End fitting for anchor combi lashing track	50 mm	140000082200



Technical data

- > material: steel galvanised
- > LC: 1000 daN

Designation	Webbing width	Item number
End fitting for anchor combi lashing track	50 mm	140000082601



Technical data

- > material: steel galvanised
- > LC: 750 daN

Designation	Webbing width	Item number
End fitting for keyhole	50 mm	140000082800

One-way Key-Lock quick lashing system



The WISTRA one-way lashing system is an economical alternative to conventional lashing straps and consists of polypropylene fabric, buckle and a tensioning tool.

The KEY-LOCK system is mainly used to secure cargo in containers, aeroplanes, trucks and trains and on ships.

The reusable tensioners guarantee simple and quick lashing.



Key-Lock webbing: Technical data

- > one-way lashing system
- > minimum breaking force: 2,000 daN
- > fabric width: 50 mm
- > presentation: 100 m roll

Designation	Item number
Key-Lock endless webbing tape 50 mm	410013850070



Key-Lock buckle: Technical data

- > one-way lashing system
- > minimum breaking force: 2,000 daN
- > material: steel, vinyl-coated

Designation	Item number
Key-Lock buckles 2 t	411800000015

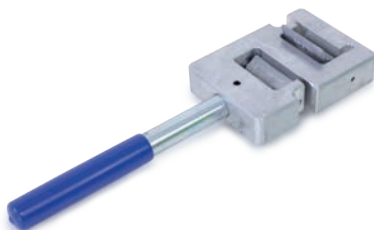

Key-Lock manual tensioning device: Technical data

- > one-way lashing system
- > material: aluminum

Designation	Item number
Key-Lock manual clamping device aluminum	410000008120

Reel tensioner



Technical data

- > for straps up to 20 mm

Designation	Item number
Reel tensioner, Type AVT, 9-20	420000000615

Buckles for straps



Technical data

- > one-way lashing
- > VPE = 1,000 pieces

Designation	Item number
Unistrap-Buckles, 13 mm	420400000012
Unistrap-Buckles, 16 mm	420500000012
Unistrap-Buckles, 19 mm	420600000012

Strapping for one-way lashings



Technical data

- > width: 9 mm
- > tensile strength: 275 daN
- > presentation: 1,500 m roll

Designation	Item number
Unistrap packaging tape 9 mm	420080300000

- > width: 13 mm
- > tensile strength: 390 daN
- > presentation: 1,100 m roll

Designation	Item number
Unistrap packing tape 13 mm	420080400000

- > width: 16 mm
- > tensile strength: 470 daN
- > presentation: 850 m roll

Designation	Item number
Unistrap packaging tape 16 mm	420080500000

- > width: 19 mm
- > tensile strength: 570 kN
- > presentation: 600 m roll

Designation	Item number
Unistrap packaging tape 19 mm	420080600000

Edge protection 5500



Technical data

- > with reinforcement and chamfer
- > for strap widths up to 65 mm
- > colour: black
- > material: plastic
- > side length: 172 x 132 mm
- > practical for paper roll transports or similar goods

Designation	Item number
Edge protection black 65 mm	165500000040

Edge protection 5501



Technical data

- > with reinforcement and chamfer
- > for strap widths up to 65 mm
- > colour: black
- > material: plastic
- > side length: 172 x 132 mm

Designation	Item number
Edge protection Econom	165501000040

Edge protection 5502



Technical data

- > with reinforcement and chamfer
- > for strap widths up to 75 mm
- > colour: black
- > material: plastic
- > side length: 180 x 130 mm

Designation	Item number
Edge protection Jumbo	165502000040

Edge protection 5503



Technical data

- > with reinforcement and chamfer
- > for strap widths up to 75 mm
- > colour: black
- > material: plastic
- > side length: 175 x 55 mm
- > special reinforcement for webbing to have an optimal pressure distribution

Designation	Item number
Edge protection Strong Paper	165503000040

Edge protection 6600



Technical data

- > with chamfer
- > for strap widths up to 85 mm
- > colour: red
- > material: plastic
- > side length: 140 x 140 mm
- > for the flexible use of sensitive goods up to the transport of building materials

Designation	Item number
Edge protection red 85 mm	166600000040

Edge protection 2200



Technical data

- > light version
- > for strap widths up to 100 mm
- > colour: white
- > material: plastic
- > side length: 95 x 95 mm

Designation	Item number
Edge protection white 100 mm	162200000240

Edge protection 3000



Technical data

- > lengths: 800 mm / 1,000 mm / 1,200 mm / 6,000 mm
- > format: 190 x 190 mm
- > colour: orange
- > material: plastic
- > edge protector for the transport of building material or similar goods

Designation	Item number
Edge protection 190 x 190 orange 800 mm	16300040-0800
Edge protection 190 x 190 orange 1,000 mm	16300040-1000
Edge protection 190 x 190 orange 1,200 mm	16300040-1200
Edge protection 190 x 190 orange 6,000 mm	16300040-6000

Edge protection 2500



Technical data

- > for strap width 25 mm
- > material: plastic
- > colour: black
- > weight: 22 g
- > side length: 55/95 mm

Designation	Item number
Edge protection black 25 mm	1625000000040

Edge protection / ratchet pad 1630

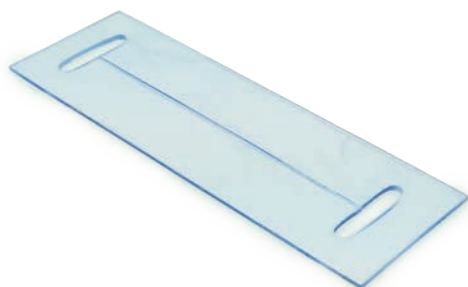

Technical data

- > for strap widths up to 50 mm
- > colour: transparent
- > material: plastic, polyurethan
- > material thickness: 3,8 mm

Designation	Item number
Edge protection ratchet pad 50 mm, slotted	163003

Special feature: The soft material adapts well to goods with round shapes and thus protects the cargo from being scratched by the ratchet or the strap.

Edge protection hose 1020 rubberised



Technical data

- > for strap widths up to 50 mm
- > material: PVC
- > surface: rubberised
- > colour: blue
- > sold by the metre
- > material thickness: approx. 1,2 mm,
exterior width: approx. 66 mm

Designation	Item number
Edge protection hose 50 mm rubberised	161020000040

Special feature: The soft material adapts well to goods with round shapes and thus protects the cargo from being scratched by the strap.

Edge protection hose 1020 polyester

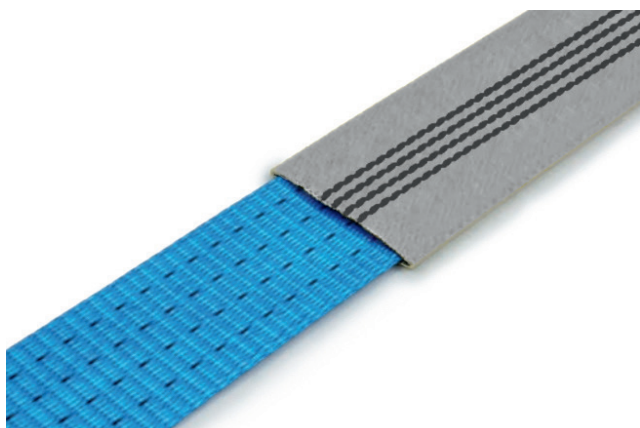

Technical data

- > for strap widths up to 50 mm
- > material: polyester
- > colour: grey
- > sold by the metre
- > material thickness: approx. 0,7 mm,
exterior width: approx. 67 mm

Designation	Item number
Edge protection hose 50 mm PES grey	161020000073

Special feature: The soft material adapts well to goods with round shapes and thus protects the cargo from being scratched by the strap.

Edge protection hose 1021



Technical data

- > for strap widths up to 40 mm
- > material: PVC
- > surface: rubberised
- > colour: blue
- > sold by the metre
- > material thickness: approx. 2 mm,
exterior width: approx. 52 mm

Designation	Item number
Edge protection hose 35 mm rubberised	161021000040

Special feature: The soft material adapts well to goods with round shapes and thus protects the cargo from being scratched by the strap.

Interesting facts

Terms

Lashing devices

consist of the tensioning device (e.g. strap, chain, cord), the tensioning element (e.g. ratchet, winding mechanism, tension lock) and possibly the connecting element (end-fitting, hook)

Lashing strap

is a lashing device consisting of the tensioning element or a lashing strap clamp and a lashing strap with or without connecting element.

Strap

is a woven textile strap

Tensioning element

is a mechanical device for introducing the tension force in a lashing device

End-fitting

is a device for connecting the lashing strap or the tensioning element with the lashing point or the fixture point of the load

Initial tension indicator

is a device indicating the initial tension in the lashing system

Single-part lashing strap

is a lashing device consisting of a textile strap and a tensioning element (use of freely moveable end fittings is possible)

Two-part lashing strap

is a lashing device consisting of two woven textile straps, one with a tensioning element, and both with one end-fitting

Length l_G – single-part lashing strap

measured from the end of the lashing strap up to the outer turn radius of its connection with the tensioning element

Length l_{GF} – short end

measured from the bearing point of the terminal bracket up to the outer turn radius of its connection with the tensioning element

Length l_{GL} – long end

measured from the end of the strap up to the bearing point of the terminal bracket piece

Minimum breaking force BF_{min}

the breaking force for which a lashing strap is designed

Lashing capacity LC

the highest force for use in straight traction for which a lashing strap is designed

Functional factor

the relation between fixed minimum breaking force BF_{min} and lashing capacity LC

2 – for tensioning element and terminal bracket

3 – for strap

Hand force HF

force on the grip of the tensioning element that produces traction in the lashing strap

Standard hand force SHF

prescribed hand force of 500 N = 50 daN specified on the label

Standard tension force STF

the remaining force after the grip of a ratchet has been let go at the prescribed hand force of 50 daN

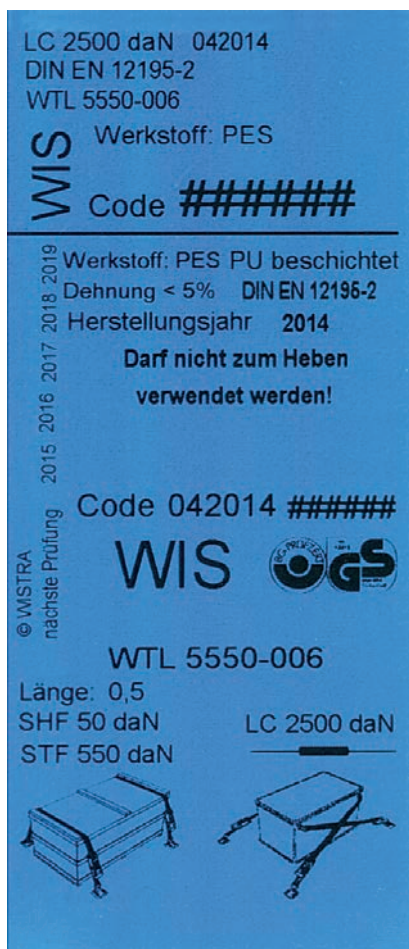

the WIS label (example WTL 5550-006 SE 0.5 m)

The WIS label

Reusable polyester lashing straps are furnished with one blue label for single-part lashing straps and with one label on each of the long ends and the short end for two-part lashing straps, which contain the following information:

WIS label short end:

- > lashing capacity: LC value in daN
- > standard Hand Force: SHF 50 daN
- > standard Tension Force: STF value in daN
- > Warning: May not be used for lifting!
- > material specification: PES (for lashing straps with polyester webbing)
- > stretching of the lashing strap in % for LC value
- > name or symbol of the manufacturer
- > WIS tracking code
- > standard specification: EN 12195-2
- > year of manufacture

WIS label long end:

- > lashing capacity: LC value in daN
- > Warning: May not be used for lifting!
- > material specification: PES (for lashing straps with polyester webbing)
- > stretching of the lashing strap in % for LC value
- > name or symbol of the manufacturer
- > WIS tracking code
- > standard specification: EN 12195-2
- > year of manufacture

User information, additional label and User Manual

Benutzerinformation

Es dürfen nur unbeschädigte Zurrgurte verwendet werden, deren Etikett lesbar ist. Unsachgemäße Ladungssicherung stellt eine Gefahr für das Leben von Personen, Tieren oder Gütern im Gefahrenbereich dar. Die praktischen Hinweise zur Benutzung und Pflege von Zurrgurten gemäß DIN EN 12195 - 2 Anhang B sind unbedingt einzuhalten.

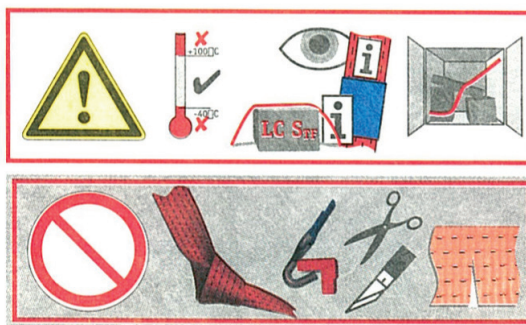

front page

back page

Handling of straps

Only lashing straps which are furnished with legible labels may be used. The label must prove that the strap complies with DIN EN12195-2. No mechanical aids such as rods or levers which do not belong to the tensioning element may be used.

Lashing straps may not be knotted. Lashing straps must be protected against friction and abrasion as well as against sharp edges (see edge protectors).

Handling of ratchets

The strap end of the long end is threaded in the winding shaft of the ratchet. By actuating the ratchet lever, the belt strap is wound up and thus tensioned owing to the drive shaft rotation. The lashing strap must be wound at least 1.5 times around the winding shaft to ensure the belt strap fits tightly. However, no more than three strap layers may be wound to prevent the lock slider from becoming stuck. To release the belt strap, the function slider must be pulled and the ratchet lever must be swivelled by approximately 180 degrees towards the limit stop. The initial tension is thereby released with a jolt. Therefore, the load must be checked beforehand for possible danger.

Correct handling of ratchets



1. After pulling the function slider, lift up the ratchet lever and then insert the strap.

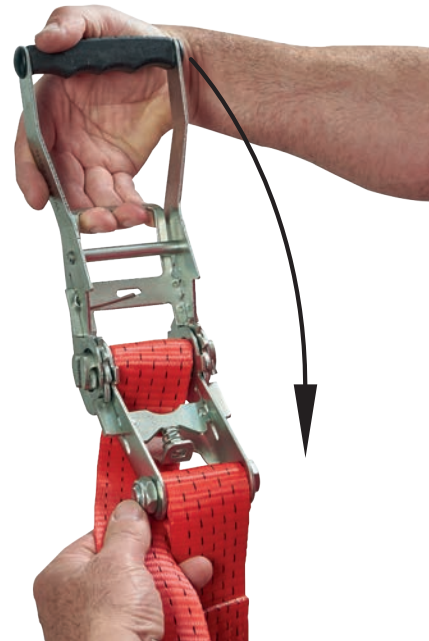

2. Pull the function slider and turn down the ratchet lever by approximately 180 degrees to release.

Checking lashing straps and load securing devices.

In terms of the VDI 2700 Guideline, all devices used for load securing must in principle be subjected to an annual test by a qualified and authorised person. As a supplementary measure in terms of DIN EN 12195-2, testing of lashing straps made of chemical fibres is recommended before and after every use. WISTRA recommends this for all load securing devices.

Discard criteria means that the lashing strap must be withdrawn from use once specified wear characteristics become visible.

Some discard criteria for lashing straps:

- Data on the lashing strap labels is illegible.
- cuts in the material wider than 10% of total width - e.g. for lashing straps with a width of 50 mm = approx. 5 mm
- damage through heat or chemical influences
- increased corrosion, cracks and/or other deformations on the connecting elements (hooks) as well as the tensioning element (ratchet)

Note: Particularly the winding elements must undergo close inspection.

- The end-of-life of a lashing strap cannot be determined solely by its year of manufacture!

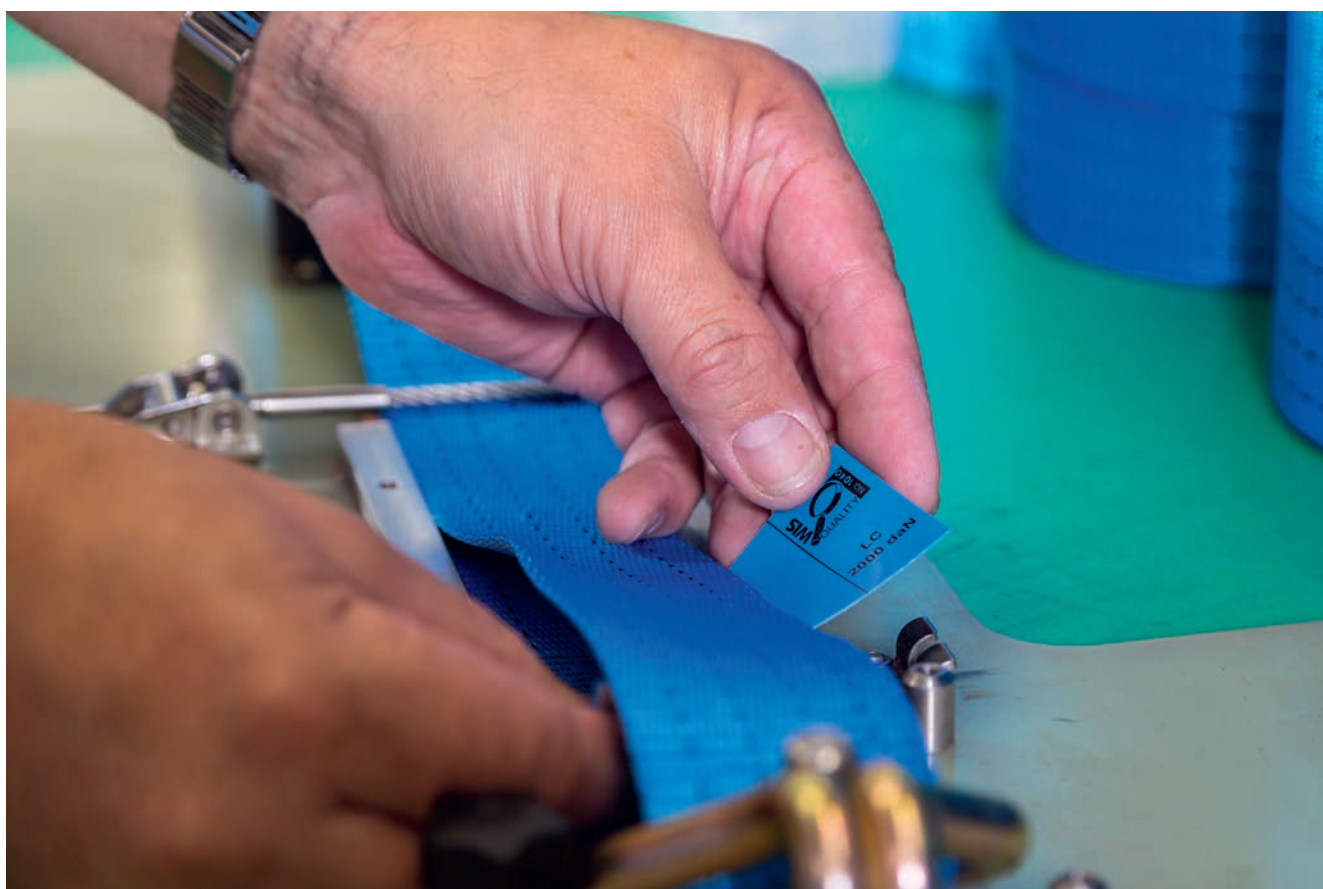

WORLD  CLASS

CARGO

SECUREMENT

KEEPING PEOPLE **SAFE**

SINCE 1986

WISTRA
CARGO CONTROL
THE HEICO COMPANIES

WISTRA GmbH
Cargo Control
An der Trave 11 • 23923 Selmsdorf
Phone: +49 (0) 388 23 / 258-0
Fax: +49 (0) 388 23 / 258-23
E-mail: info@wistra.eu

UAB "Wistra Cargo Control"
Pramones 8
LT-94102, Klaipeda
Tel.: +370 61024943
Tel.: +370 69565282
E-mail: masiule@wistra.eu

www.wistra.eu



You can also visit us on Facebook:
www.facebook.com/wistra.eu